



3

**Nuclear Transmutations;  
New Sources of Energy  
and Some Anomalous  
Phenomena**



## 3.1 Cold Nuclear Fusion and Nuclear Transmutations

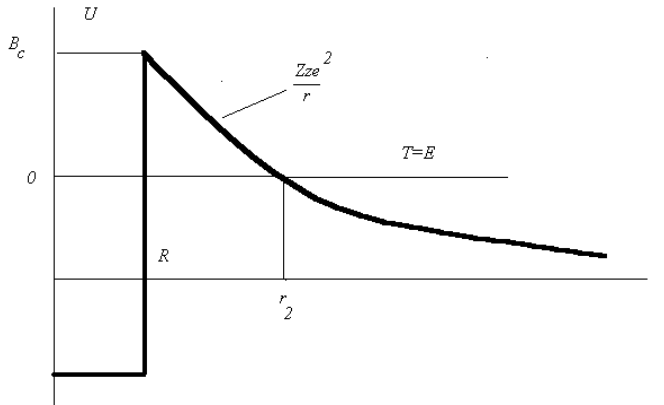
*“The kernels are pure emeralds,  
But people, it may be, lie...”*

*A. S. Pushkin*

### 3.1.1 Introduction

Let us analyze the epoch-making experiments carried out by M. Fleishman and S. Pons in the March of 1989 [71] and revealed for the first time the phenomenon called the cold nuclear fusion (or Low Energy Nuclear Reactions-LENR), i.e. the nuclear synthesis at low temperature. Notice, one of the authors of this book (prof. Leo Sapogin) has already predicted in 1983 [72] in his works the possibility of such nuclear reactions at small energies. Without going into well-known details we can say: the phenomenon of the cold nuclear fusion really exists and no one physicist can explain it clearly within the classical mechanics or within the standard quantum mechanics. The series of various mechanisms which explain this intriguing phenomenon is offered but it is hard to believe them because of the following reasons.

The curve of nuclear potential energy in the case of a charged particle interaction with a nucleus is plotted in Fig. 3.1.1, where the right top part of the curve corresponds to the mutual Coulomb repulsion that nucleus and charged particle is experienced.



**Fig. 3.1.1** Potential corresponding to nuclear fusion.

The repulsion potential is described by formula

$$U(r) = \frac{Zze^2}{r},$$

where  $Ze$  is the nucleus charge,  $z$  is the charge of particle moving to the nucleus,  $e$  is the electron charge;  $r$  is the distance between given particle and nucleus. At  $r=R$  the potential energy curve has a jump that can be explained by the appearance of the intensive nuclear attraction. Nowadays, we do not know any mathematical formula for the potential of the nuclear attraction. If the charged particle is able to overcome the potential barrier of the height

$$B_c = \frac{Zze^2}{R} \approx \frac{ZZ}{\sqrt[3]{A}} \text{ MeV},$$

then further the particle falls into the region of nuclear forces of attraction and the nuclear reaction will proceed.

Let us consider the nuclear interaction if the charged particle possesses kinetic energy  $T < B_c$ . From the classical mechanics point of view in that case there will no nuclear reaction at all because reaching some distance  $r < R$  to the Coulomb

barrier top the particle will be turned back and reflected. Deuteron energy in ordinary electrolytic cell of Fleishman-Pons is near 0.025 eV, the height of Coulomb barrier in this case is  $B_c = \frac{Zze^2}{\sqrt[3]{A}} = 0.8MeV$ . It is naive to discuss the question about overcoming the barrier with the height dozens of million times more than the kinetic energy from the classical mechanics point of view.

However, from quantum mechanics point of view there is a tunneling effect and the probability of such tunneling, or potential barrier transparency  $D$ , is given by well-known formula:

$$D \approx \exp\left(-\frac{2}{\hbar} \int_{r_1}^{r_2} \sqrt{2\mu(U-T)} dr\right) \tag{3.1.1}$$

where  $\mu = \frac{Mm}{M+m}$  is so called reduced mass,  $M$  is the nucleus mass,  $m$  is the particle mass. The lower limit of integration  $r_1$  coincides with nucleus radius  $R$ , the upper limit  $r_2$  corresponds to condition  $T = \frac{Zze^2}{r_2}$ . After integrating we will obtain

$$D = \exp(-2g\gamma)$$

where  $g = \frac{R}{\lambda_{B_c}}$ ;  $\gamma = \sqrt{\frac{B_c}{T}} \arccos\left(\sqrt{\frac{T}{B_c}}\right) - \sqrt{1 - \frac{T}{B_c}}$ , and value  $\lambda_{B_c} = \frac{\hbar}{\sqrt{2mB_c}}$ , is de Broglie wavelength, corresponding to the particle kinetic energy equal to the barrier height  $T = B_c$ . If  $T \ll B_c$ , then formula (3.1.1) can be easily transformed into the form

$$D = \exp\left(-\frac{2\pi R B_c}{\hbar v}\right) = \exp\left(-\frac{2\pi Z z e^2}{\hbar v}\right) \quad (3.1.2)$$

where  $v$  is velocity.

If we estimate the values  $g$  and  $\gamma$  for collision of two neutrons with such energy, then we obtain following:

$$g = \frac{R\sqrt{2mB_c}}{\hbar} = 1.9; \quad \gamma = \sqrt{\frac{B_c}{T}} \arccos\left(\sqrt{\frac{T}{B_c}}\right) - \sqrt{1 - \frac{T}{B_c}} \approx 8883,$$

hence the probability of such a process equals to  $\exp(-2 \cdot 1.9 \cdot 8883) \approx 10^{-7328}$  (!). The cross-section of fusion reaction can be determined as multiplication of nuclear cross-section and tunneling probability, i.e.

$$\sigma = \sigma_{nucl} D.$$

Moreover, if the deuteron sighting parameter does not equal zero, then the appearance of centrifugal potential

$$U = \frac{\hbar^2 l(l+1)}{2mr^2}$$

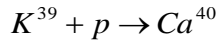
will lead for more reducing of interaction probability.

### 3.1.2 Experimental Results

The obtained values do not require a commentary. It is quite explainable that the official physical science has rejected every talk about the possibility of the LENR-Low Energy Nuclear Reactions. The experiments of M. Fleishman and S. Pons [71] were declared as some misunderstanding. For example, the most serious and responsible edition Encyclopedia Britannica 2001 could not even find a place

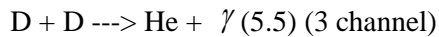
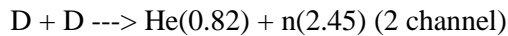
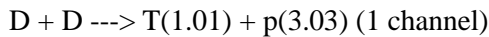
for the cold nuclear fusion concept. Such official viewpoint can be understood only if one considers standard quantum mechanics as absolutely valid. In spite of all during last 14 years starting from the moment of experimental discovery of M. Fleyshman and S. Pons about 50 international conferences dealing with that subject were organized, there are a lot of books, Journals, and magazines discussing this problem, the number of articles written about it is near to dozen of thousand. Today the situation is changing step by step into positive direction. And the researches are slowly turning away from the high road of hot fusion that has wasted during last 60 years more than 90 billion dollars for nothing.

The LENR experimental data are extremely numerous and various, but we are going to dwell on the most important and fixed results. Thus at classical electrolysis study of the palladium cathode saturated with deuterium there is enormously great heat generation in heavy water: up to 3-kilowatt/ cm<sup>3</sup> or up to 200 megawatt-second in a small sample. There were also detected fusion products: tritium ( $10^7 - 10^9$  t/sec), neutrons with the energy equal to 2.5 MeV (10-100n/sec), helium. The absence in the products of the reaction  $He^3$  shows that heat does not the result from the reaction d+p. More over one can observe the emanation of charged particles ( $p, d, t, \gamma$ ). We can study similar processes at gas discharge over palladium cathode, at phase change in various crystals saturated with deuterium, at radiation treatment of deuterium mixture by strong sonic or ultrasonic flux, in cavitations micro-bubbles in heavy water, in a tube with palladium powder saturated with deuterium under the pressure of 10-15 standard atmospheres and others. In some reactions, (for example at  $d+t \rightarrow \alpha + p$ ) neutrons with the energy 14 MeV are absent; one can meet the same strange situation in other cases too. Thus the participation of nucleus  $Li^6, Li^7$  in reactions with deuterium and protons, while the reaction



was fixed even in biological objects. But the most intriguing fact in all these processes is the lack of fusion products that could explain the calorific effects. Thus, in some cases the number of fusion products (tritium, helium, neutrons, and quantum) should be million times more to give any explanation of the quantity of the heat evolved. So great energy liberation can be explained neither by chemical or nuclear reactions nor by changes of phase. More details about the magic source of such energy are given in the books [200, 201]

The deeply studied interaction d+d proceeds along three channels:



These reactions are exothermic. The third channel has very low probability. In the result of experiments it have been discovered that these reactions can take place at indefinitely small values of energies. In molecule of  $D_2$  the equilibrium distance between atoms is 0.74Å and according to standard quantum theory these two deuterons would be able to come into nuclear fusion by chance. But the value of the interaction is quite small [59] and equals  $\lambda_{D_2} = 10^{-64} c^{-1}$ . We know from literature [59] estimation: the water of all seas and oceans contain  $10^{43}$  deuterons and there would be only one fusion within  $10^{14}$  years. It is evident from the sated above that the main obstacle preventing d+d reaction is the presence of an extremely high Coulomb barrier. The approach given in the [172, 200, 201] allows solving that problem. The UQT also gives such possibility. Solutions of some UQT equations show that distance the deuterons could draw depend strongly on the



phase of wave function (by the way that is absolutely evident by intuition).

### 3.1.3 Low Energy Nuclear Reactions (LENR) and Nuclear Transmutations at the Unitary Quantum Theory

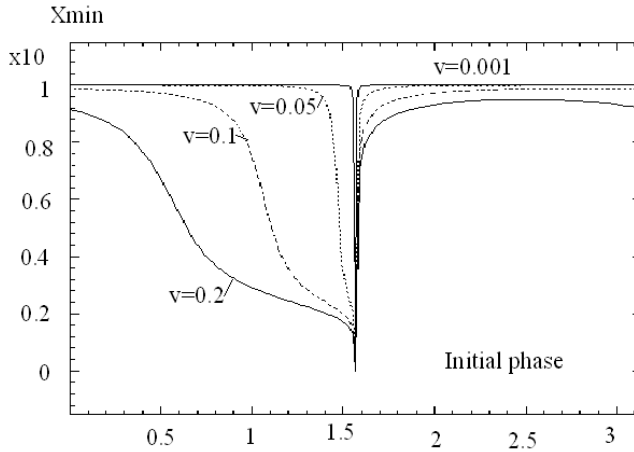
Let us consider the motion of a charged particle to the nucleus from the viewpoint of UQT using the equation with oscillating charge in one-dimensional case [200, 201, 53-58, 172]. Assume there is an immovable nucleus with the charge  $Ze$  placed in origin  $x = 0$ , and the particle with the charge  $ze$ , and mass  $m$  is moving towards this nucleus with some initial velocity along axis  $x$ . Autonomous and non-autonomous equations of the particle motion are derived from Schrodinger equation for very small kinetic energy [200, 201, 53-58, 172] and have the following form for Coulomb potential :

$$m \frac{d^2x}{dt^2} = \frac{2Zze^2}{x^2} \cos^2 \left( \frac{m}{\hbar} \frac{dx}{dt} x + \phi_0 \right), \quad (3.1.3)$$

$$m \frac{d^2x}{dt^2} = \frac{2Zze^2}{x^2} \cos^2 \left( \frac{m}{2\hbar} \left( \frac{dx}{dt} \right)^2 t - \frac{m}{\hbar} \frac{dx}{dt} x + \phi_0 \right), \quad (3.1.4)$$

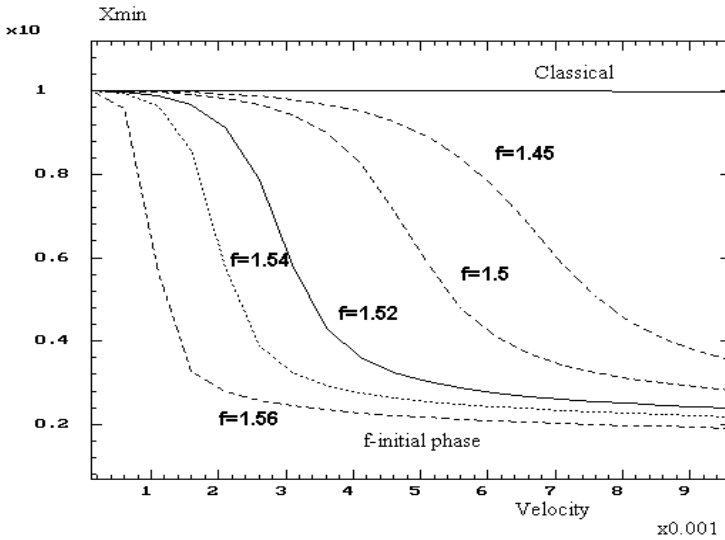
where  $\phi_0$  is the initial phase. These equations are numerically integrated under following starting data:  $Z=z=1$ ,  $e=1$ ,  $m=1$ ,  $x_0 = -10$ ,  $\hbar = 1$  and different initial velocities and initial phases. As it is expected, the particle's braking and acceleration took place in the moments the oscillating charge is big. But at the final stage at some initial phases close to  $\frac{\pi}{2}$  a delightful process appeared. The velocity, charge and repulsive force are very small. Due to the phase relationship small charge stay constant during the long period, and that means that nothing affects particle (or, rather, its remainder), the particle very long snails with low

and constant velocity inside the other particle field (“snail effect”) and may approach its center at close distance. That process bears a strong resemblance to slow inconspicuous spy penetration into the hostile camp.



**Fig. 3.1.2** Distance to the turning point of moving charge in respect to value of initial phase for different velocities.

That phenomenon appears within some area of phases and is convenient to call it a phase hole, which is illustrated by plots in Fig. 3.1.2 (obtained after integration of the equation (3.1.4)). Besides, it may be possible now to explain one of the anomalies of the nuclear physics (which does not exist according to physics literature). When the nucleon energy equals 1 MeV its velocity equals  $10^9$  cm./sec., nucleus radius equal to  $10^{-12}$  cm., the time of flight through nucleus equals  $10^{-21}$  sec., but time interval within which the nucleon flies out is usually anomalous huge -  $10^{-14}$  sec, it is even out of understanding what does the nucleon do inside the nucleus for such a long time? But it can be easily explained in the frame of our theory by “snail effect”. That phenomenon is studied more detailed in books [200, 201] and Section 3.1.4.

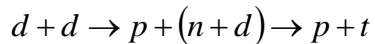


**Fig. 3.1.3** Minimal distance between charges in respect to initial velocity for different values of initial phase.

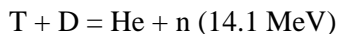
For the same equation, the minimal distance between charges was computed depending as a function of the velocity and at various values of the initial phase. For comparison, the result of classical computation on the base of Coulomb law is shown in Fig. 3.1.2. We can see from the same plots that the minimal distance at which the particle is able to come near the nucleus does not depend on the kinetic energy. But with the decrease of velocity the width of initial phase interval corresponding to minimal distance decreases too. In other words with decrease of energy the probability of nuclear fusion also decreases. We obtain on the whole the same results for autonomous equation (3.1.3).

In accordance with the standard quantum theory the relation of fusion velocity along tritium and neutron channels should be near unity:  $\frac{t}{n} \approx 1$ . But the results of numerous experiments of the cold fusion show that value greatly differs from

unity and equals  $\frac{t}{n} \approx 10^9$ . That value is reproduced in different experimental situations and by various experimental groups with a high accuracy. Till now that quite intriguing problem has not been solved. We will try to explain the possible reason for that. Neutrons are influenced at low velocity within the phase hole by forces of nuclear attraction and protons - by the forces of electrostatic repulsion. Under the influence of momentum of given forces the deuteron have enough time to turn in such a way that its neutron parts are turned to each other. After the neutrons attraction the saturation of nuclear forces appears. That weakens the connection between protons and one of them is able to leave the system. Schematically, the reaction may be rewritten in the form



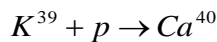
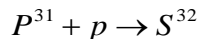
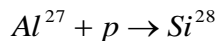
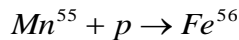
That looks like effect of Oppenheimer-Phillips [74]. But it is precisely known that at high energies the probabilities of the first and the second channels of the reaction are similar and that phenomenon should be anyhow explained. The growth of the probability of neutron channel with the increase of the energy may deal with the secondary neutrons birth in reaction



In medium full of heavy hydrogen the most part of being born tritons will transform into neutrons due to that reaction. The cross-section of this reaction is equal to 5 barn at energy of 70 KeV. In accordance with the estimate in [74], the numbers of so secondary neutrons for one triton are  $7.9 \cdot 10^{-12}$ ,  $1.7 \cdot 10^{-9}$ ,  $2.7 \cdot 10^{-6}$  for the triton energies 10, 20 and 100 KeV correspondingly. Thus the prevalence  $\frac{t}{n} > 10^6$  must be expected in those reactions only, where the birth of tritium corresponds to energies higher than 40 KeV [74].

We should not think that phenomenon of phase hole will result in nuclear reaction over the whole area of the hole. We can assume that along with decrease of Coulomb repulsion value, the value of the strong interaction decreases too. How? Today nobody knows the exact equation for strong interaction potential. Furthermore the particle reaches turning points  $x_{\min}$  “losing flesh (charge) enough”. Will the particle be able to participate in an honest nuclear reaction or just pass it through as an electron in s-states of atom does? But there are very narrow phase areas where shortly after the particle stops its charge is rapidly growing and particle velocity increases abruptly. The charge may be even maximal within the scope of nuclear forces. Apparently this narrow area is responsible for the cold nuclear fusion. And probably at strong interactions the phase hole is working too.

It was discovered long ago that nuclear transmutations are widely spread (it is especially evident for plants and biological objects), but they are faintly connected with energy liberation. The examples of such reactions are:



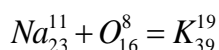
In reactions of such a type very slow proton (its kinetic energy is equal practically to zero) is penetrating inside the nucleus by the above-mentioned way and stays there. There is no nuclear energy liberation, because the nucleus remains stable both before and after reaction. In accordance with classical nuclear physics, the nucleus, as usual, after a charged proton with great kinetic energy gets inside it, becomes unstable and breaks to pieces, and its fragments obtain bigger kinetic energy. The reactions of above-mentioned type were

considered impossible at all at small energies and therefore were not studied in the classical nuclear physics. Apparently, that is absolutely new type of nuclear transmutations unacknowledged by modern nuclear science, but experimentally discovered sufficiently long ago. Today there are a lot of experimental data confirming the mass character of nuclear transmutation. Moreover there are many projects of nuclear waste neutralization that use this method. The journals “Infinite Energy”, “New Energy”, “Cold Fusion”, “Fusion Facts” etc. and Internet is full of such projects.

Of course, if the charge of a nucleus changes, then the electron shells of atom also will re-form, but the energy dealing with that process will be of few electron-volts order and cannot be compared with in any case with the energies of nuclear reactions that are from units till hundreds of billions electron-volts. By the way, experts in nucleonic got used to that range energies in nuclear reactions. Exactly that circumstance forces them it to reject a priori the presence of any nuclear processes in biology, because at such debris’ energies dozens and hundreds of thousands of complex biological molecules will be destroyed.

Quite far ago Louis C. Kervran [75] published the book about nuclear transmutations in biology, and now nearly 20 years after it was reissued! Apparently for the first time numerous experimental data describing the above-mentioned phenomena were presented. The reaction of official science was also quite interesting. For example, the well-known physician Carl Sagan after having read the book about experimental results advised Kervran to read an elementary course of nuclear physics!

A little bit later Panos T. Pappas [154] researched one of the nuclear reaction perfectly observed within biological cells, viz.



The existence of  $K - Na$  balance is well known in the classical biology for the long time. The ratio between quantities of K and Na ions is kept with a great accuracy in spite of presence of any K or Na ion in the food. Later in the work [155] that nuclear reaction was called “equation of life” and M. Sue Benford proved with direct physical methods the presence of such nuclear reactions in biological objects. To our regret the number of the researches of those problems in biology is very small. We know about the existence of such groups in Japan (Komaki), India and Russia.

All programs of controlled nuclear fusion are based on meaningless heating and pressing of the respondent material. In spite of successes achieved, the head of such a group in England Dr. Alan Hibson (private communication) announces few years ago that not less than 50 should pass before the construction of reactor for demonstration can be ready. Today that point of view becomes generally accepted. Note that the reactor itself, even if it were constructed in future (the authors greatly doubt that possibility) would be extremely complicated, expensive and environmentally pollutant.

Classical approaches have not achieved positive results yet in spite of investments of many billions and huge number of physicists, engineers, maintenance staff, managers and chief-managers involved. Of course that enormous army of researches became a potential enemy of any alternative projects of fusion. It was note that “vitality” of any idea is directly proportional to the amount of persons involved and capital invested. Those were the reasons why works of M. Fleishman and S. Pons were given a hostile reception.

Each program of controlled nuclear fusion has adjective “controlled”, but as a matter of fact there is no control at all. The initial quantity of respondent material is simply very small, quite providently we should say. For example a ball of

lithium deuteride used for laser reduction is near 1-2mm in diameter. But nobody has at least examined the question of energy recovery to be generated in the result of that ball explosion. By the way the energy from that explosion is nearly equal to energy obtained in the result of an anti-tank grenade explosion.

Straightforward approach to nuclear fusion used by modern science is absolutely natural because there is no method in the standard quantum mechanics to influence that process. The future of systems of really controlled nuclear fusion will possibly lie not on the path of the primitive and meaningless heating and pressing of the respondent material but on the path leading to the collision of nuclei possessing a small charge and micro adjusted wave function phase.

That is possible in principle by the superposition of controlling external electromagnetic field on the reactive system containing quasi-fixed order atoms of deuterium and free deuterons. The special atomic lattice geometry may produce the same characteristics. Dispersion of a deuterons flow due to diffraction on such lattice will result in automatic selection of deuterons in energies and phases.

Apparently in electrochemical experiments carried out by M. Fleishman and S. Pons, such ordered system existed inside the Pd-D lattice and as the result appeared weak phasing able to explain the results of experiments raised [77, 78].

We suppose that in future models of the reactors in contrast to all existing projects will react in any moment of time only the smallest part of deuterons automatically selected relative to initial phases. It could be possible to obtain in result the small energy generating during long period of time until the reserve of light reacting nuclei will not be exhausted. That fusion does really have the right to be called “controlled”.

Today we can imagine that in the future the processes of cold fusion will be



adopted probably not in energy production but for atomic wastes utilization and isotopes manufacture.

Many experimentalists [77, 78] discovered that the quantity of the heat generated in the common water electrolysis over nickel electrodes (in that system we cannot even expect nuclear fusion presence) were the same as in the case with electrolytic lattice with heavy water. That fact confirms the results of other experiments in the process of which it was discovered that the number of fusion products was in millions times less than it was necessary for that quantity of generated heat, and its origin was mysterious. We had examined the question of heat origin in books [200, 201, 66].

The thermal cell CETI (created by James Patterson in 1995 [66]), where electrolyze of specially manufactured nickel bolls in common water is going on, has shocked scientists in USA. American newspaper «Fortean Times» No 85, 1995, wrote about it: “December the 4th, 1995 will go down to history!” At that day the group of independent experts from five American Universities tested the work of new energy source with stable output heat rating 1.3 kWatt. The electric energy input was 960 times less.” All experts noted that generated heat had enigmatic origin and could be explained neither by chemical or nuclear reactions nor by phase transitions. By American ABC TV there were two telecasts at 7th and 8th of February, 1996 in cycles «Nightline» and «Good Morning America» about Patterson creation of new source of energy, able to generate in hundred times more energy than it had consumed. And again it were accentuated that the origin of generated heat remains mysterious. It is interesting that American Company Motorola made attempts to buy the patent for cell CETI for US\$ 20.000.000, but was rejected (private communication). We are sure that Motorola Company had spent a certain sum for the study of that problem before making so serious an offer. All processes within the Patterson cell do not concern

nuclear reactions (although Patterson thinks otherwise), and at our opinion can be explained with the same processes used here above [200, 201, 83-86] for the description of proton-conductive ceramics.

### 3.1.4 Dynamic Processes in Low Energy Nuclear Reactions

Further we will give certain concrete data demonstrating the phase values of a deuteron with an oscillating charge, under which the deuteron can approach the nucleus to a critical distance of  $10^{-12}$  cm or less, i.e. giving the data for estimating the value of the above-mentioned phase hole in the interval  $(0, \pi)$  of the phase change.

Assume that the stationary nucleus with the charge  $q$  is placed at the coordinate origin  $x=0$  and a deuteron with the same charge  $q$  is placed at the initial moment  $t=0$  at the point  $x_0 < 0$  on the  $x$ -axis, and the deuteron velocity equals  $\dot{x}_0 = v_0 > 0$ . Charge  $q$  is equal to dimensionless electron charge 0.085137266 (see Chap1.8). The units of mass, length and time are chosen in such a way that  $m=1, \hbar = 1, c = 1$  ( $m$  – deuteron mass,  $c$  – light velocity). According to

International unity system SI (kg, m, s)  $m = 3.34734 \cdot 10^{-27}$  kg,  $\hbar = 1.0545 \cdot 10^{-34} \frac{kg \cdot m^2}{s}$  We take velocity the value  $3 \cdot 10^8$  m/s. Our units are connected (up to 4 significant figures) with the system (kg, m, s) as follows:

$$1 \text{ mass unit} = 3.347 \cdot 10^{-27} \text{ kg},$$

$$1 \text{ length unit} = 1.050 \cdot 10^{-16} \text{ m},$$

$$1 \text{ time unit} = 3.500 \cdot 10^{-25} \text{ s}.$$

The electron velocity corresponding to its energy of 1 eV equals  $5.931 \cdot 10^7$  cm/s.

The deuteron velocity corresponding to such energy will be assumed to be 3675 times less, and in our units it will be  $5.380 \cdot 10^{-7}$  cm/s. Then the deuteron movement towards the nucleus is described by the equation

$$\ddot{x} = -\frac{2q^2}{x^2} \cos^2\left(\frac{1}{2}(t + t_*)\dot{x}^2 + x\dot{x} + \varphi_0\right), \tag{3.1.5}$$

where the parameter  $t_*$  is defined under the condition that the argument of cosine equals  $\varphi_0$  for  $t = 0, x = x_0, \dot{x} = \dot{x}_0$  (thus  $t_* = -(2x_0)/\dot{x}_0$ ), and this parameter may be considered as the initial moment of so called local time.

We are particularly interested in solutions of (3.1.5) under very small deviation  $\varepsilon$  from the phase  $\varphi_0 = \frac{\pi}{2} + \varepsilon$  and rewrite (3.1.5) in the following form:

$$\ddot{x} = -\frac{a}{x^2} \sin^2\left(\frac{1}{2}(t + t_*)\dot{x}^2 + x\dot{x} + \varepsilon\right), \tag{3.1.6}$$

where  $a = 0.0144967$ . Let the initial  $x_0$  be equal  $-500000$  of our length units (i.e. approximately  $5 \cdot 10^{-9}$  cm) and the initial deuteron velocity  $v_0$  be equal to the velocity  $v_{00}$  corresponding to the deuteron energy of 1 eV or less. But it turned out that the precision of numerical integration of this equation under such initial conditions and under values  $|\varepsilon| = 10^{-6}$  and less is small and besides the interval of the integration must be very large. That is why this equation also had to be transformed by passing to “slow” time  $\tau = |\varepsilon|t$  to the equation with respect to the variable  $w = \left(\frac{dx}{d\tau}\right)^2$  as a function of  $x$ :

$$\frac{dw}{dx} = -\frac{2a}{x^2} \left\{ \frac{1}{\varepsilon^2} \sin^2 \left[ \left| \varepsilon \left( \frac{1}{2} (\tau + \tau_*) w + x \sqrt{w \pm 1} \right) \right| \right] \right\}, \quad (3.1.7)$$

where  $\tau_* = -(2x_0) / \sqrt{w(x_0)}$  and +1 if  $\varepsilon > 0$ , and -1 if  $\varepsilon < 0$ . It must be added also the equation for  $\tau$  as a function of  $x$ :

$$\frac{d\tau}{dx} = \frac{1}{\sqrt{w}}. \quad (3.1.8)$$

The system of equations (3.1.7, 3.1.8) is, so to say, a “model” system describing fairly accurately (from viewpoint of quantities data) the deuteron movement under all values of  $|\varepsilon|$  from  $10^{-24}$  to  $10^{-6}$ . The numerical integration of this system was carried out under different values of  $\varepsilon$  and under following initial conditions:

$$w(x_0) = 2.103, \tau(x_0) = 0, x_0 = -500000, \tau = 689573.18 \quad (3.1.9)$$

It may be noted that the initial deuteron velocity  $v_0$  equals  $1.450172 * |\varepsilon|$  (following the relation  $\dot{x}_0 = |\varepsilon| \sqrt{w(x_0)}$ ) and for  $|\varepsilon| = 10^{-7}$  such velocity is approximately 3.7 times less than velocity  $v_{00}$  corresponding the deuteron energy of 1 eV. If  $|\varepsilon| = 10^{-6}$  then the velocity  $v_0$  is approximately 2.7 times greater than velocity  $v_{00}$ .

It turned out that the numerical tables for values of  $w, \tau$  obtained under different values of  $\varepsilon < 0$  in the interval  $(-10^{-24}, -10^{-6})$  don't differ essentially from each other. The following table is true up to three-four significant figures for  $\tau$  and  $\dot{x} / |\varepsilon| = \sqrt{w}$ :

$x$	$\tau$	$\dot{x}/ \varepsilon $
-500 000	0	1.450
-50 000	$1.426 \cdot 10^6$	0.0493
-500	$1.002 \cdot 10^7$	0.000489
-200	$1.067 \cdot 10^7$	0.000440
-100	$1.090 \cdot 10^7$	0.000425
-80	$1.100 \cdot 10^7$	0.000423.

If reducing the table values of  $x$  to centimeters, we obtain the following corresponding approximate values:

$$5 \cdot 10^{-9}, 5 \cdot 10^{-10}, 5 \cdot 10^{-12}, 2 \cdot 10^{-12}, 10^{-12}, 0.8 \cdot 10^{-12} \text{ cm}$$

The time interval  $\Delta T$ , in which the deuteron reaches the critical distance  $10^{-12} \text{ cm}$  from the center is  $1.090 \cdot 10^7 / |\varepsilon|$  of our time units or  $(1.090 \cdot 10^7 / |\varepsilon|) \cdot 3.500 \cdot 10^{-25}$  seconds. If nuclear forces are not taken into account then the deuteron may approach the distance less  $10^{-12} \text{ cm}$ . We present here for illustration the table, where the initial deuteron velocities  $v_0$  in velocities shares  $v_{00}$  and the corresponding time intervals  $\Delta T$  (in seconds) for different values of  $\varepsilon$  are listed.

$\varepsilon$	$\frac{v_0}{v_{00}}$	$\Delta T$ (s)
$-10^{-6}$	2.7	$3.82 \cdot 10^{-12}$
$-10^{-7}$	0.27	$3.82 \cdot 10^{-11}$
$-10^{-22}$	$0.27 \cdot 10^{-15}$	$3.82 \cdot 10^4$ ( $\approx 10.6$ hours)
$-10^{-23}$	$0.27 \cdot 10^{-16}$	$3.82 \cdot 10^5$ ( $\approx 106$ hours)

Let us note that the given data changes essentially under positive values of  $\varepsilon$  ( $10^{-6}$ ,  $10^{-7}$ , etc.) There is some asymmetry of solutions behavior under negative and positive values of  $\varepsilon$ . The calculations show the minimal distance  $|x|_{\min}$  more than 500 of our lengths units even for relative big initial  $w(x_0) = 10000$ . Thus, if we limit ourselves to the condition that the deuteron energy is not over  $0.27v_{00}$  at a distance of  $5 \cdot 10^{-9}$  cm from the central nucleus, and the whole process of deuteron movement towards the nucleus does not exceeds approximately 10.6 hours, then the interval  $(\frac{\pi}{2} - 10^{-7}, \frac{\pi}{2} - 10^{-22})$  is approximately the sought phase hole in the whole interval  $(0, \pi)$  of phase change  $\varphi_0$  in Eq. (3.1.5).

If many deuterons with velocity not more than  $0.27v_{00}$  at the distance  $5 \cdot 10^{-9}$  cm from the nucleus are equally distributed along their phases  $\varphi_0$ , the ratio of the length of this hole to  $\pi$ , equaling approximately  $0.3 \cdot 10^{-7}$ , is equal to the share (or the respective percentage of  $0.3 \cdot 10^{-5}$ ) of deuterons overcoming the Coulomb barrier.

The above figures express at least the order of probability of the LENR occurrence, and this order is absolutely incompatible with the figures in the standard quantum mechanics mentioned above. Let us note once again that a one-dimensional problem was solved, and in case of an accurate analysis (not zero sighting distance will be taking into account) this probability will be lower. Let us also pay attention to the large time intervals  $\Delta T$  calculated if  $|\varepsilon|$  is very small. It explains well the effect (observed by many researchers) of continuation of cold fusion reactions even many hours after disconnection of the voltage in the electrolytic cells. This effect was named even “life after death”.

As for the analysis of the deuteron movement with the help of the autonomous equation, the calculations lead to initial velocities  $v_0$ , exceeding the above mentioned numbers, although the general motion picture is the same. But the autonomous equation is interesting, because in the area of those values  $x, \dot{x}$ , under which the product  $x\dot{x}$  has a small modulo, it is possible to replace  $\sin(x\dot{x})$  with  $x\dot{x}$ , and consider under  $\varepsilon = 0$  the following equation (describing the deuteron motion from initial point  $x_0 > 0$  to the center)

$$\ddot{x} = a \frac{(x\dot{x})^2}{x^2} = a\dot{x}^2$$

This equation has a very simple analytical solution. Without giving very simple calculations, we will present the final formulas.

Let us take the following initial conditions:

$$x(0) = x_0 > 0, \quad \dot{x}(0) = -v_0 < 0$$

Then

$$\dot{x}(t) = -\frac{v_0}{1 + av_0t}, \quad x(t) = x_0 - \frac{1}{a} \ln(1 + av_0t).$$

It follows from these formulas that the velocity of a particle moving in accordance with the initial equation never turns to zero, and under

$$t = t_* = \frac{\exp(ax_0) - 1}{av_0}$$

$x(t_*) = 0$ , i.e. the particle reaches the center of the nucleus, its velocity at this moment being

$$\dot{x}(t_*) = \frac{-v_0}{1 + av_0 t_*} = -v_0 \exp(-ax_0),$$

so that it passes through the nucleus and moves further!

For example, let  $a=0.0144967$ ,  $x_0 = 1000$  ( $\approx 10^{-11}$  cm),  $\dot{x}(0) = 5.37 \cdot 10^{-10}$  ( $\approx 16$  cm/s). Under such initial data, the product  $x\dot{x} = -0.0000537$ , so it is quite possible to replace  $\sin(x\dot{x})$  with  $x\dot{x}$ . In this case,

$$t_* \approx 2.3 \cdot 10^7 \quad (\approx 8 \cdot 10^{-18} \text{ s}),$$

$$\dot{x}(t_*) \approx -29.9 \cdot 10^{-17} \quad (\approx 9 \cdot 10^{-6} \text{ cm/s})$$

These figures fit well into the reasonable framework, so the autonomous model can also be used for the movement analysis in the problem under review. The phenomenon of particle passage through the Coulomb potential accounts very well for the existence of pendulum orbits in the Bohr-Sommerfeld model, when in states 1s, 2s, 3s etc. the electron passes through the nucleus. Such states in the strict theory and experiment have no impulse, so in the Bohr-Sommerfeld model they were discarded as absurd. Now they have a right to exist. Further, the experimental data for angular distribution of non-elastic scattering by nuclear reactions (including reactions with heavy ions) reveal the big amplitude of the scattering forward. It is impossible to explain such effect by the formation of intermediate nuclei but it may be explained from the viewpoint of our UQT.

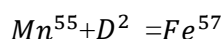
### 3.1.5 Transmutation of Isotopes in Biosystems

Discussing LENR problems, it seems to be a good idea to pay some attention on dramatic story of extremely interesting results in biological investigations of transmutation of isotopes in biosystems. The problem of transformation of the matter became perfectly real. Some words from Russian scientists V. Vysotskyj



and A. Kornilova in their book “Nuclear fusion and transmutation of isotopes in biological systems” [203]: ... - On the grand scale, life itself, realized as a form of existence of protein objects, is a big mystery. It is an anti anthropic process, maintaining order in the world of chaos. Its explanation from the point of view of a big fluctuation cannot, essentially, explain anything... Stability of DNA, giving the probability of mutation of no more than  $10^{-7}$  regardless of local conditions and the makeup of nutrient media, is one such mystery.

The objective of conducted experiments was detection and study of the possibility of running a low-temperature transmutation of isotopes in growing microbiological cultures. Having acknowledged the need for simple registration, we made the decision to use the Mossbauer effect on the basis of isotope  $Fe^{57}$  in our first experiments. Iron is the integral part of the majority of live organisms. Importantly, for most biological objects, the regular isotope  $Fe^{57}$  and the rare Mossbauer isotope  $Fe^{57}$  are identical. From the point of view of nuclear physics, they are completely different nuclei. Those experiments were based on the expected synthesis reaction of the Mossbauer isotope  $Fe^{57}$



in a microbiological culture, that grows in the iron-poor water-salt nutrient medium based on the heavy water  $D_2O$  containing manganese salt. Among the undisputable advantages of using manganese is its single stable isotope  $Mn^{55}$ . This circumstance makes interpretation of experimental results unambiguous. The result of the expected synthesis reaction is formation of a rare stable isotope  $Fe^{57}$ , concentration of which in natural iron is very small and equals 2.2%. The apparent advantage of this reaction is  $Fe^{57}$  - the most studied Mossbauer isotope, it can be easily identified using the Mossbauer effect. Accumulation of this isotope with increasing of the reaction's efficiency and its duration makes

possible (at least in perspective) to study temporary patterns of transmutation process.

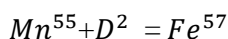
Above all, since natural concentration of  $Fe^{57}$  isotope is small, its synthesis can be easily registered by traditional mass-spectrometry based on the analysis of changes in relative distribution of isotopes of iron. In the course of conducting the experiments, a thorough check for artifacts was performed.

The experimental data has shown that:

Isotope  $Fe^{57}$  is not found in significant quantities in the ingredients of the nutrient medium;

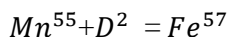
Isotope  $Fe^{57}$  is not present in heavy water and cannot be extracted from glass or air during the microbiological culture's growth. The structure of the gamma-absorption specter of  $Fe^{57}$  isotope in cultures grown in the media based on light and heavy water is the same.

Therefore,  $Fe^{57}$  isotope, detectable after completion of the microbiological cultures' growth in the optimal nutrient medium is not related to artifacts and is generated in the low-temperature reaction of nuclear transmutation



in the process of these cultures' growth.

Finally, we shall examine thermodynamic consequences of the given reaction. Since the reaction of synthesis



is energetically efficient and should run with energy emission, the average power, which could be generated in the dish with the optimal nutrient medium, can be

calculated from the difference of mass defects of the nuclei participating in the reaction  $Mn^{55} + D^2 = Fe^{57}$ . The difference of mass defects of the isotopes participating in the reaction of transmutation is equal 15.605 MeV. Using the experimentally obtained values, authors [203] calculated that the average power, generated during the process of transmutation in a dish with volume  $V = 10 \text{ cm}^3$ , does not exceed the value of 75--40 mWt.

Leaving aside the special question of distribution of this energy among products of the reaction, we note, that this power — even if fully converted into heat — could not significantly alter the thermal regime of culture's growth (especially provided that the growing process was performed in an automatic thermostat).

Numerous experiments with the LENR (including the latest of Andrea Rossi - Italy) have shown that nuclear reactions do exist but the nuclear reactions products by themselves are not enough for the explanation of huge amount of heat being produced. It is the responsibility of the UQT solutions “Maternity home” [183, 195, 200, 201]. So it looks like catalysis mechanism described in [173, 185]. Besides all the equation with oscillating charge is quite good in describing the wave properties of the particle. We predict that experiments on the diffraction reflection of electrons from the lattice (classical experiments of Davisson-Germer) can be simulated by supercomputer, but authors do not have such possibility.

There are especially many such facts in the fringe areas, where different sciences are closely and unusually intertwined (for example, biology, physics, chemistry). On the grand scale, life itself, realized as a form of existence of protein objects, is a big mystery. It is an anti anthropic process, maintaining order in the world of chaos. Its explanation from the point of view of a big fluctuation cannot, essentially, explain anything.

Other phenomena occurring in living objects are not less mysterious. Stability of DNA, giving the probability of mutation of no more than  $10^{-7}$  regardless of local conditions and the make up of nutrient media, is one such mystery. This fantastic procreative consistency throughout the whole specter of external conditions cannot be explained by the effect of a DNA polymerase controlling that process. In a nutrient environment, some necessary chemical elements may be missing, external conditions may change, and yet the process of undistorted and non-mutating procreation prevails with constantly high efficiency! Even super powerful radiation fields cannot disrupt it. The bacterial culture “Deinococcus Radiodurans” comfortably lives multiplies and does not mutate in radiation fields with the dose exceeding 10 Mrad.

Many structural materials cannot sustain such dose of radiation (not to mention such materials as crystallized silicon, which is the basic material for all microelectronic devices, and which completely degrades in such conditions), but a biological object, maintained by the rules of genetic information can successfully live and develop! It appears that biological objects have an internal source of high stability and reliable self-regulation, which inanimate objects do not have. How does it happen? Where is that internal source of stability? What are the limits of self-regulation? Can these processes be controlled?

Why can a living system, seemingly fragile and sensitive to external conditions, perform the process, which is practically impossible to achieve (at least with a comparable degree of efficiency) in inanimate objects? How does it do it? Why does it do it?

When answering these questions, we proceed strictly from solid facts and methods of modern science. We are not inventing new myths, but basing our deliberations on the principle of “not to create any substance in excess of the

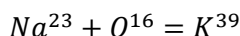
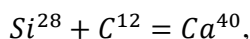
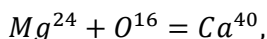
necessary” and trying to explain all facts using the tested methods, without introducing (as it is often done) a new radical theory to explain each fact. In this respect we are definite conservatives.

For this reason, we don't think, that the totality of the effects being analyzed can be called “biological transmutation”. That name would give it a semi-mystical flavor, which, by no means, reflects the essence. In reality, it is transmutation of nuclei (isotopes) in biological systems occurring according to strict laws of physics, but induced by certain features of biological objects' structure, functioning as stimulators and intrinsic in dynamic living systems.

The series of works by Louis C. Kervran [75] holds a special place in the chronology of transmutation of chemical elements and isotopes in biological objects. Effectively, he was the first scientist of the post-nuclear era, who conducted systematized research of possible transmutational processes of chemical elements in biological objects. In his works Kervran gave numerous examples of unusual changes in the chemical composition of various biological objects, which occurs during their growth. He explained these changes on the basis of existing concepts of transmutation of chemical elements.

For example, among the most important, he investigated the reaction of potassium transmutation into calcium in the biological system containing hydrogen (with a participating proton). His works contain reasonably convincing experimental results. This data corresponds to changes in potassium and calcium content in the process of growing seeds and were obtained from the analysis of 840 seeds and 403 sprouts. It can be seen that the decrease in the amount of potassium ( $K = -0.033 \text{ g}$ ) and the increase in the amount of calcium ( $K = 0.032 \text{ g}$ ) are approximately equal. Meanwhile, the amount of magnesium stays practically unchanged.

Kervran also investigated many other reactions of transmutation of isotopes, among which several should be specifically noted for their vital activity importance in producing essential elements Ca, K, Mg, P.



The objective of conducted experiments was detection and study of the possibility of running a low-temperature transmutation of isotopes in growing microbiological cultures.

With other hand, may be, there is no nuclear energy liberation, because the nucleus remains stable both before and after reaction. Apparently, that is absolutely new type of nuclear transmutations unacknowledged by modern nuclear science, but experimentally discovered sufficiently long ago.

### **3.2 Conservation Laws and Unitary Quantum Theory; Perpetuum Mobile and Modern Science**

*E. Rutherford disdained complicated theories and considered any theory being good for nothing if it cannot be told to a barmaid.*

*Hans Frauenfelder & Ernest M. Henley. Subatomic Physics.*

Inventors and swindlers of every stripe and range many years tried to construct or even to design perpetuum mobile, i.e. imaginary mechanism able to work without outside energy supply. Peter the First (Russian Emperor Peter Great) had

even established Russian Academy of Science for such researches (see. V. L. Keerpechev, “Talks about mechanics”, Gostechisdat, 1951, page 289), but today persons from modern Russian Academy of Science would like to forget that circumstance. At the other side French Immortals have decided in 1775 to consider no projects of perpetuum mobile, and it seems they have not been mistaken yet. However one mistake is known: Daniel Bernoulli was awarded a prize by French Academy for mathematical proof that a boat with engine and screw propeller would never have faster speed than sailing ship!

Magnificent successes of classical thermodynamics have strengthened Humanity confidence in Divine Infallibility of Conservation Laws. Today it is considered nearly indecent to call in question these laws.

First of all let us clarify the origin of conservation laws in classical mechanics [158, 159]. Nearly each textbook contains a statement that Energy Conservation Law (ECL) results from homogeneity of time, Momentum Conservation Law results from homogeneity of space, and Angular Momentum Conservation Law – from isotropy of space. And so many people are impressed that Laws themselves result from space-time properties that nowadays are no doubt a relativistic conception. But for example angular momentum is not a relativistic conception already. Therefore such restricted approach is not totally correct; Newton's second law of motion or relativistic dynamics equation and concept of system closeness should be attracted. More over the requested space-time properties themselves are usually wrongly being interpreted. For example, it is assumed that time homogeneity means simple equivalence among all moments of time and homogeneity and isotropy of space means equivalence of all its points and absence of preferential direction in space (all directions are equal) correspondingly.

But these statements are sensu stricto wrong. For example, within many mechanical systems the Earth center direction and horizontal direction differ in

principle (for example, pendulum clock located in horizontal plane will not work at all). We can say the same about the body being at the top of the hill, it is able to roll down independently, but according to classical mechanics it never climbs by itself. And for a person, being young or old, these moments of time are not equal at all. Hereinafter we would like to explain in what way all that should be understood.

Time homogeneity implies that, if at any two moments of time in two similar closed systems somebody runs two similar experiments, their results would not differ.

Space homogeneity and isotropy means that if closed system is moved from one part of the space to another or oriented in other way, nothing would be changed.

Derivation of energy and momentum conservation laws from Newton equation is quite simple in idea. Viz., let us write down the main equation of dynamics in form of

$$\mathbf{F} = \frac{d\mathbf{P}}{dt} \quad (3.2.1)$$

For closed system  $\mathbf{F}=0$  (there are no external forces) and the equation possess the integral

$$\mathbf{P} = \text{Const}$$

expressing the momentum conservation law.

Now let's write the main equation of dynamics in the form:

$$\mathbf{F} = m\mathbf{A} = m \frac{d\mathbf{V}}{dt}$$

and scalar-wise multiply it by  $\mathbf{V}$



$$\mathbf{F} \cdot \mathbf{v} = m \frac{dv}{dt} v = \sum_{i=1}^3 m \frac{dv_i}{dt} v_i = \sum_{i=1}^3 m \frac{d}{dt} \left( \frac{v_i^2}{2} \right) = \frac{d}{dt} \left( \frac{mv^2}{2} \right),$$

where  $v$  is a modulus of velocity vector  $\mathbf{v}$ . For the closed system  $\mathbf{F}=0$  it exists the integral

$$\frac{mv^2}{2} = \text{Const } v_i^2$$

expressing one of the forms of energy conservation law.

Using the definition of the angular momentum for the particle, i.e.

$$\mathbf{L} = [\mathbf{r} \times \mathbf{P}]$$

and differentiating it both parts by  $t$ , we obtain

$$\frac{d\mathbf{L}}{dt} = \left[ \frac{d\mathbf{R}}{dt} \times \mathbf{P} \right] + \left[ \mathbf{r} \times \frac{d\mathbf{P}}{dt} \right]$$

As the momentum vector is parallel to velocity vector, the first bracket is equal to zero. And basing on the equation (3.2.1) and on definition of central force, as one does not create a momentum, we get

$$\left[ \mathbf{R} \times \frac{d\mathbf{P}}{dt} \right] = 0$$

and

$$\mathbf{L} = \text{Const.}$$

In the case of central force within unclosed system angular momentum remains constant in value and direction.

The energy and momentum conservation laws can be easily obtained within relativistic dynamics from relativistic relation between energy and momentum

$$E^2 = P^2 c^2 + m^2 c^4$$

The term  $m^2 c^4$  is an invariant, i.e. it is similar within all reference frames. In other words it is a kind of constant. This relation can be written in rather different form

$$E^2 - P^2 c^2 = Const$$

To satisfy that relation one should admit that

$$E = Const \quad \text{and} \quad P = Const$$

And that is nothing else than energy and momentum conservation laws.

But strictly speaking in relativistic mechanics there is a law of conservation of four-momentum vector  $P^\mu$ , but we are not going to stop at these details.

In accordance with the classical mechanics, the energy conservation law signifies that energy of closed system remains constant, hence, if at the moment  $t=0$  the energy of such system is denoted by  $E_0$ , and at the moment  $t$  is denoted by  $E_t$ , then

$$E_0 = E_t.$$

In accordance with standard quantum theory, the energy conservation law is laid down in the same way. Within that theory we have the same integrals of motion as in classical mechanics. Some value  $L$  would be an integral of motion if

$$\frac{d\hat{\mathbf{L}}}{dt} = \frac{\partial \hat{\mathbf{L}}}{\partial t} + \left[ \hat{\mathbf{H}}, \hat{\mathbf{L}} \right] = 0 \tag{3.2.2}$$

As  $\left[ \hat{\mathbf{H}}, \hat{\mathbf{L}} \right]$  is determined by commutator of operator  $\hat{\mathbf{L}}$  and of Hamilton's

operator  $\hat{H}$ , so any quantity  $L$ , being not evidently dependent on time will be an integral of motion if its operator commutes with  $\hat{H}$ . When quantity  $L$  is not evidently dependent of time, then the first terms in (3.2.2) vanishes. As remainder we have

$$\frac{d\hat{L}}{dt} = \left[ \hat{H}, \hat{L} \right], \quad (3.2.3)$$

and, as we know, the quantum Poisson bracket vanishes for the integrals of motion being not evidently dependent on time. Thus,

$$\frac{d}{dt}(L) = 0.$$

In any good work dealing with quantum theory it was shown that probability  $w$  to observe at any moment  $t$  any value of such motion integral  $L$ , does not depend on time either. We will denote below such integrals of motion  $L_n$ . As far operators  $\hat{L}$  and  $\hat{H}$  commuted they had common eigen-functions that were functions of stationary states. We should note that the last were obtained from solution of Schroedinger equation without time (not containing  $t$ ) which is derived from full Schroedinger equation if

$$\Psi(r, t) = \Psi_0(r) \exp\left(i \frac{E}{t}\right),$$

i.e. if this equation has the periodic solutions. The solutions of Schroedinger equation not containing  $t$  satisfy conservation laws, which are, in fact, dictated by condition of total time-independence. The expansions of such solutions in eigen-functions' have the form

$$\hat{L}\Psi_n = L_n\Psi_n,$$

$$\hat{H}\Psi_n = E_n\Psi_n,$$

where

$$\Psi(x,t) = \sum_n c_n \Psi_n(x) \exp\left(-i \frac{E_n}{\hbar} t\right) = \sum_n c_n(t) \Psi_n(x), \quad (3.2.4)$$

$$c_n(t) = c_n \exp\left(-i \frac{E_n}{\hbar} t\right) = c_n(0) \exp\left(-i \frac{E_n}{\hbar} t\right).$$

As (3.2.4) is eigen-functions' expansion of the operator  $L_n$ , the probability does not depend on time, i.e.

$$w(L_n, t) = |c_n(t)|^2 = |c_n(0)|^2 = Const$$

We should note once more that it is the probability to observe some given value that is time-independent, while, the value itself is occasional in each individual case. As far the energy is an integral of motion and probability  $w(E, t)$  so at the moment  $t$  energy value is equal to  $E$  and time-independent, then:

$$\frac{dw(E, t)}{dt} = 0$$

Quantum energy conservation law in the above mentioned form assume the possibility of energy determination at the current moment of time not taking into account its uncontrolled changes due to influence of the process of measurement itself. That situation have not risen any doubts within classical mechanics. But according to quantum theory (as we have written already in section 2.13), the energy can be measured without disturbance of its value only up to

$$\Delta E \geq \frac{\hbar}{\tau},$$

where  $\tau$  - is the duration of measuring process. Formally, there are no troubles for energy conservation law, as the energy is the integral of motion and we have arbitrary large time interval to accomplish long measuring. For example, let measure within time  $\tau$ , then leave the system alone for the time  $T$ , and then measure the energy once again. In standard quantum mechanics the energy conservation law states that the result of the second measuring will coincide to  $\Delta E \approx \frac{\hbar}{\tau}$  with the results of the first measurement. But even according to standard quantum theory all this is not totally logical, because really existing vacuum fluctuations may meddle and they are able to change the result. Here we have evident violation of conservation law due to vacuum fluctuations, although the integrals of motion exist (contrary to UQT).

The standard quantum theory carefully avoids the question of conservation laws for single events at small energies. Usually that question either does not being discussed at all, or there are said some words that quantum theory does not describe single events at all. But these words are wrong, because the standard quantum theory describes, in fact, single events, but is able to foreseen only the probability of that or other result. It is evident that at that case there are no conservation laws for single events at all. These laws appear only after averaging over a large ensemble of events. As the matter of fact it can be easily shown that classical mechanics is obtained from quantum one after summation over a large number of particles. And for a quite large mass the length of de Broglie wave becomes many times less than body dimensions, and then we can not talk about any quantum-wave characteristics any more.

It is well known that local laws of energy and momentum conservation for the individual quantum processes are valid within all experiments at high energies only. We can not say so in the cases of low energies at least due to uncertainty relation and stochastic nature of all predictions in quantum theory.

The idea of global but not local energy conservation law is invisibly presenting in quantum mechanics and in any case is not new. From the physical viewpoint it just means that in stationary solutions with fixed discrete energies (standard quantum mechanics) the velocity of a particle reflected from the wall is equal to the velocity of an incident particle. If the particle energy decreases at each reflection, then that case corresponds to solution type “Crematorium” and if increases – to “Maternity Home” solution. The scenarios under which events will be developed depend on the initial phase of the wave function and particle energy.

In the strict Unitary Quantum Theory and in the theory of quantum measuring (chapter 1) un-removable vacuum fluctuations play a great role. It is quite clear that these fluctuations are totally unforeseen and non-invariant with respect to space and time translations. In other words, within UQT there are no habitual space-time properties. Now space-time is heterogeneous and non-isotropic. For example, if the experiment is replaced in any other point of the space or repeated at other time, then in the point where the particle’s parameters were examining and particle is interacting with macro-device, another value of vacuum fluctuations would appear (differing from the previous one) that would give another result. Of course that is true for small energies and individual events (particles) only.

The Unitary Quantum Theory is much more destructive with regards to the notion of Closed System. For single events at small energies that notion is inapplicable at all because at any moment of time and in any place where the particle is located (for example, within potential hole) vacuum fluctuation may be

abruptly changed. It may occur thanks to various causes; either due to the nature of vacuum fluctuations, or due to the tunneling effect of other random particle.

Few times it has been stated that energy conservation laws follow from E. Noether theorem, although those results have been contained in the works of D. Gilbert and F. Klein. For any physical system, the motion equations of which can be obtained from variational principle, every one-parameter continuous transformation, that is keeping the variation functional invariant, corresponds only one differential law of conservation and so explicitly conserved value exist. However, it can be easily seen that vacuum fluctuations being imposed on varying functional (Lagrangian) does not remain constant (in any case it seems so today) under parametrical transformations. That consideration does not work too without ensemble averaging either.

In other words, each requirement that leads to classical laws of conservation is absent now. It is hard to expect that the entire laws of conservation will remain valid in that situation for the single particles at small energies. But nowadays it seems that classical laws of energy, momentum and angular momentum conservation for the single quantum objects do not work at small energies due to the periodic appearance and disappearance of particles. All direct experimental checks of the conservation laws were carried out in the cases of great energies but in the cases of small energies for single particles probability results could be obtained only. In that case it is indecently even to recollect the idea of conservation law.

And now a bit of Philosophy for reader. Local Energy Conservation Law (LECL) for individual processes results from the Newton equations for closed systems. It is naive to think that its local formulation will remain constant forever. And it would be a gross error to transfer ECL without alterations from Newton mechanics to quantum processes inside microcosm.

Definitely speaking references to the first law of thermodynamics are baseless because it is a postulate. For example, in his letter to one inventor the famous Russian mathematician N. N. Lousin wrote: “...*first law of thermodynamics was a product of unsuccessful attempts of the humanity to create perpetuum mobile and frankly speaking did not follow from anything*”.

Today we can say with firm belief that no resourceful machines within the network of Newton mechanics are able to realize perpetuum mobile, and the decree of French Academy, accepted in 1755 to consider no projects of perpetuum mobile is still valid. We should add that is apparently true for all projects based on Newton mechanics only.

It is characteristic of the understanding of the position of ECL in modern physics that this law is bringing down, especially in theory, to the rank of second-order conclusion from the equations of motion. Some physicists reduce ECL to the statement of the first law of thermodynamics, others as for example D. I. Blochintsev [79] consider that “it is quite possible with further development of new theory ECL form will be transformed”. As F. Engels wrote in his “Natural dialectics”: “...*no one of physicists, in particular, consider ECL as everlasting and absolute law of the nature, as a law of spontaneous transformation of substance motion forms and quantitative permanency of that motion at its transformations.*” Many of them are thinking in another manner as, for example, M. P. Bronshtein. He wrote in his work “Substance structure” ECL is one of the basic laws of Newton mechanics. And nevertheless Newton had not attributed to that law rather general character that law had in reality. The reason of that Newton mistaken point of view at ECL was quite interesting... Now it is understandable that in the light of the above mentioned such point of view was not wrong at all. And we should remind that Newton had foreseen in his “theory of about” many things even quantum mechanics.



At the other side, the founders of quantum mechanics perfectly understood that the conservation law for the single quantum processes at small energies did not exist at all. So, the first thought that understanding of ECL on a par with the second law of thermodynamics, as statistical law, being correct on average and not applicable to the individual processes with small energies, appeared as despair and went back to Erwin Schroedinger first and then to N. Bohr, Kramers, Sleter and G. Gamov. In 1923 Bohr, Kramers and Sleter in despair tried to construct the theory according to which in the process of dispersion energy and momentum conservation laws were satisfied statistically on the average during long time intervals but were inapplicable to the elementary acts. Leo Landau even called that as “Bohr perfect idea” [79].

According to that theory, the process of dispersion should be continuous, but Compton electrons are emitted in a random way. The authors assumed both processes of wave dispersion and Compton electrons dispersion were not connected with each other (?). The main idea was to lay a bridge between quantum theory of the atom and classical emission theory. There were introduced specially so called “virtual” oscillators which generate in accordance with classical theory waves (non quantum one) enable to induce the transition from the state with lower energy to the state with higher energy. These waves did not carry the energy, but power necessary for atom transition from lower to the higher state was generated within the atom itself. Along with that the inverse process of the atom transition from excited state to the lower one could take place, but the energy was not taken away by waves but should disappear inside the atom. In other words, the increase of one atom energy was not connected with energy decrease in another one. Authors considered that these processes compensated each other on average only and that compensation was the better the more events are participated. Energy conservation law has statistical character according to that interpretation, and there is no law of conservation for single events, but they appear in processes involving

large number of particles, i.e. at transition to Newton mechanics. But then it should be acknowledged that in the case of Compton effect the changes of motion direction of the light quantum and its energy to be appeared in the result of collision were happening apart from the changes of electron's state. The failure of such approach was lately experimentally proved by Bote and Geiger.

To say the truth, the authors abandoned that point of view later; moreover at that time this idea did not follow from quantum theory equations. And to get out of the tight spot it was declared that quantum mechanics did not describe single events at all. Thus the most striking paradox was removed by a simple prohibition just to think about it! But genius idea that laws of conservation are not valid for individual processes and appear in quantum mechanics after statistical averaging does not become less genius even if those for whom it "has come to mind" rejected it. Maybe, this idea was a little premature and should have a somewhat different shape.

Contrary to that Unitary Quantum Theory describes single particles. And the alteration of their behavior is determined not only by initial values of its position and velocity but also by initial phase of the wave function (of the wave packet). Then for the single particle local conservation laws do not exist at all. And that is quite another question how to measure the initial phase or any other parameters of a single particle.

Let us examine the following virtual experiment. For more simplicity let use in our reasoning some quantum ball-particle. If classical ball is running to the wall (for simplicity assume it as perpendicular), the velocity of the reflected ball would be equal to its initial velocity (we neglect friction and consider the ball and the walls as totally resilient). In the case of quantum ball the velocity of the reflected ball in various experiments with similar initial circumstances will have the whole spectrum of values: there will be balls reflected with the velocity higher than initial, equal to it and lower than initial. And all these will be

described by means of quantum mechanics within uncertainty relation.

Let us ask what would be if we placed a second wall parallel to the first one in such a way the ball at each reflection increased its velocity? Then we would get the growth of the ball energy without any efforts from our side. The aim of future constructors of such systems in XXI century would be the necessity to create such initial conditions for the great number of particles forming the object, that is realized the sole solution “Maternity Home” and is suppressed as far as possible the other solution.

It is evident from the above-mentioned that at competent exploitation of the Unitary Quantum Theory ideas the principle prohibition for perpetuum mobile does not exist. Formally as it is shown above that prohibition does not exist even in standard quantum mechanics (there is no laws of conversation for single processes with small energies), and to get energy the particles should be selected in some way (grouping together all random processes with excess energy).

But the standard quantum mechanics refuses to describe single events and is not able to advise the way for grouping. As it seems today, the Unitary Quantum Theory gives us such an opportunity.

However, by efforts of scientific groups, interested in their own stability because of simple instinct of self-preservation the great idea of free energy generation was distorted to such a degree everybody who starts to talk about it is taken for mad.

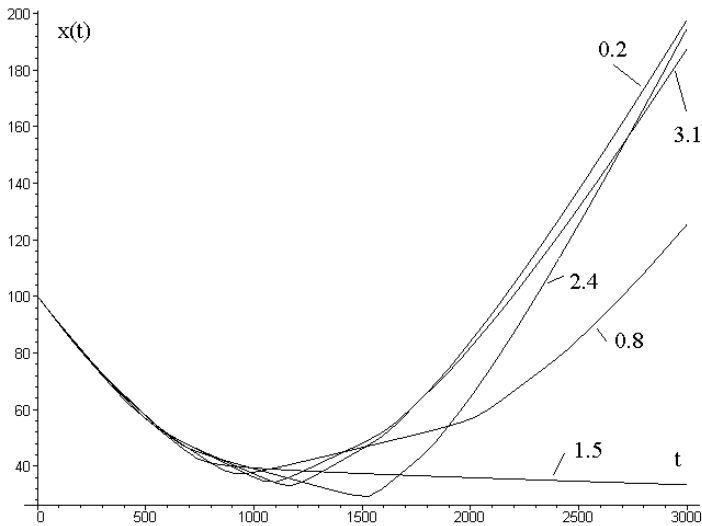
The modern experimental physics have examined the correctness of conservation laws for huge energies in single cases and for large macro-object when ensemble averaging is used, but the area of small energies is terra incognita.

Let us show an example of the conservation laws violation for single particle reflection from Coulomb potential. Viz., we have obtained the numeric solutions

of equations (3.1.3) and (3.1.4) under different values of the initial phase and following initial conditions:

$$\hbar = 1, m = 1, 2Zze^2 = 1, x_0 = 100, V_{x_0} = -0.1$$

The plots in Fig. 3.2.1 and Fig. 3.2.2 show the distances between charges as functions of time at different initial phases.



**Fig. 3.2.1** Dependence of distance between moving charges on time for solutions of equation (3.1.3).

It is evident from calculations that the velocity of reflected particle may be equal, more or less than the velocity of incident particle. It seems that the similar situation can be observed at any potential. The calculations have been carried out for the following potentials also: harmonic oscillator, Yukawa, Gauss, doublet, hyperbolic secant and Wood-Sacson. The qualitative results are similar.

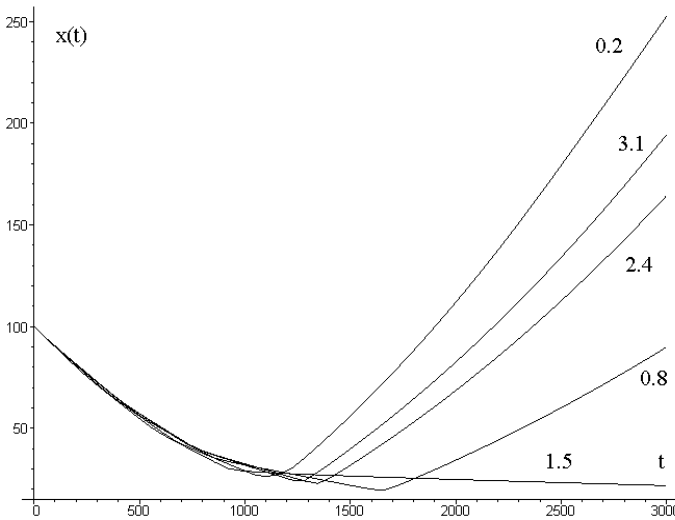
If summed the momentum of all particles falling down with different phases and compared it with summary momentum of the reflected particles, then, for example for the Coulomb potential, the summary reflected momentum would be

at few percent more than the summary momentum of the incident ones. For the other potentials so small difference may be even negative. In general, that problem is very complicated and requires additional investigations, because the results depends in a complicated manner on initial conditions (initial velocity, initial phase and distance).

From the philosophical point of view any categorical prohibitions like impossibility of perpetuum mobile creation are absolutely unacceptable. If everybody will be convinced of that forever, then the laws of conservation and prohibitions for perpetuum mobile would remain unshakable for all civilizations while humanity lives. Of course, Conservation Laws funeral can continue very long. By the way, we are not going to do that, and may be our book only clears a little the place for further grave, and sumptuous funeral with proper honors will be done by future generations. On the other side, undoubtedly, these laws will never become a thing of the past and of course will be constantly used but at the beginning there will be small areas of science and engineering where these laws application will be evidently insufficient.

The truth should be accepted irrespective of the source it came from. That is why it would be useful to cite a quotation of “Natural Dialectics” of F. Engels:

*“But when Solar System will finish its circle of life and suffer the fate of everything finite, when it will become a victim of the death, what will be later? Thus we realize that the heat radiated in world space should have the possibility in any way to be determined in future, to transform in other motion form where it will be able to be accumulated again and begin functioning. But in that case the main obstacle preventing the reverse transformation of dead suns into red-hot nebula will drop away”.*



**Fig. 3.2.2** Dependence of distance between moving charges on time for solution of equation (3.1.4).

The question whether the conservation laws exist in global form (we have already proved that it is not local) remains open. Nothing except human mentality inertia is leading to that. That inertia is based on Newton laws that have been already exchanged for the Quantum ones. Thinking inertia leads to the situations when in the cases of motion equations solving an excess energy appeared the question where it has come from arise.

Of course, if the particle (for example, photon) is falling down at half-transmitting mirror and is divided into two parts, then due to vacuum fluctuations superposition could be detected by photo multiplier tube full two photons. In this case the excess of the energy can be fixed, as if, obtained from vacuum: two photons instead of one. In other case, the photon divided at the mirror in two parts can be not detected at all and its energy is, as escaping into vacuum.

Once we have absorbed energy from vacuum, at the other time and in other act we have returned the same quantity. And so one might think, and probably such

process takes place in reality. But if we examine solutions of the equation with oscillating charge, then the laws of energy and momentum conservation do not work in principle. Vacuum fluctuations have nothing to do with it. And the question where could energy appear from is based on the inertia of our thinking and as a matter of fact is an atavism, dictated by the Newton mechanics.

It is interesting that even in logical definition of the energy there is a bomb. If the energy is something that can neither arise nor disappear and is just always transforming from one form into another the single value that obeys these conditions is null. We are far from the thought that energy does not exist at all.

But the problem of its existence is being solved in various philosophical systems in different ways, but it seems the most correct approach is mathematical: an object exists if it is free from contradictions. But energy was not lucky, and thanks to that approach it should be null.

And many cosmologists would like to have theories, which assume that there are in Universe localities where the energy is coming into being and also other localities where the energy annihilates. For example, British astronomer Fred Hoyle has developed the theory of Universe where the continuous creation of matter takes place. He wrote:

*“... Different atoms constituting the matter do not exist at some given moment of time and then after instant they exist already. I must admit this idea may look as strange... But all our ideas about creation are strange. According to previous theories the whole quantity of matter in Universe was coming into being just as whole and all process of creation looks as super-gigantic instant explosion. As for me, such idea seems much stranger, than idea of continuous creation...” F. Hoyle, La nature de l’Universe, 1952.*

The official astronomical science does not accept the ideas of F. Hoyle and of some other astronomers (H. Bondi, T. Gold, P. Jordan) about continuous creation of matter in Universe because the Conservation Laws are considered as infallible. But from the viewpoint of our UQT these ideas are not so strange.

### **3.3 Energy Generation in Potential Well and New Energy Sources**

*The highest mastery both in theory and practice is the ability to transfer a problem into postulate.*

*Jogann Wolfgang von Goethe*

The energy carrier in mechanical systems is usually the moving mass. Its locomotion uses some form of energy. Contrary to that, in a wave process in any medium the energy is carried by the wave, and in this case the energy carrier does not deal with the carriage of mass, but the energy and the mass are connected by a proportionality constant. There are waves able to carry negative energy, but those arise within the inversion mediums and we are not going to examine so exotic case. As far energy and mass are different sides of the one quite hazy object, the energy generation and the mass generation are two names of one and the same process. As we will see later this takes place in UQT.

The ancient classical idea «perpetuum mobile» assume that energy is simply created but not obtained from outside (the impossibility of «perpetuum mobile» is in fact the first law of thermodynamics).

A lot of articles and even books examining the idea of energy extraction from vacuum appeared recently. We slightly touch in section 3.10 the problem of



energy extraction in a random process and the interpretation (in our point of view, sometimes not entirely correct) of that problem.

One group of main ideologists of that new trend in science are Daniel C. Cole and Harold E. Puthoff, their first serious work titled «Extracting energy and heat from the vacuum» was published in *Physical Review E*, vol.48, #2, (1993). Here the authors are exploiting Quasi-space Casimir forces. The appearance of such forces in vacuum could be intuitively described in the following way. Suppose two big parallel plates placed in blustery sea. Outside of those plates the waves would strike in rather random way and there would not be waves between the plates at all. The result of wave strikes from the outside of the plates would be attraction appeared between them (it is the Casimir forces experimentally detected long ago). The authors of that interesting work were going to exploit that power. It is easy to see that here the energy is obtained from vacuum fluctuations.

In our approach everything is otherwise. Solving the equation with oscillating charge for the quantum oscillator we have detected 4 types of solutions. The most important for us are two of them: the “Crematorium” and the “Maternity home”. According to one of them (the “Crematorium”) the particle slowly descends to the well bottom and in the end transforms into a phantom (in accordance with strict UQT the particle has disappeared, has got spread all over the Universe, and makes its contribution to vacuum fluctuations everywhere). In accordance with the other solution – the “Maternity home” - the particle is able to appear from rather small fluctuation and produce quite big energy.

We should underline once again that both processes are not connected logically to each other. In other words, one can imagine mathematical systems where energy either vanishes (electrolytical baths, see paragraph 3.4) or unrestrictedly increases (probably, it is our Universe). And the energy conservation law is the greatest drag in any cosmological points of view. However, the theories

considering the Universes, where the creation of matter takes place (see above sect. 3.2), appeared in scientific cosmology long ago independently of us. The question whether such model is realized in the nature at all and whether the energy generated by quasars a result of some huge well effect, - will be the most intriguing questions of future.

We should note once again that it is not clear yet whether the values of appearing and disappearing energy corresponding to our solutions are equal. But the vacuum (as enormous set of random oscillations) is considered in no way as the source of the energy generation within UQT. Of course UQT admit such exchange between vacuum and energy (section 1.5)

For example, in the case of a photon splitting on a translucent mirror sometimes both photon halves are not detected, they vanish (put out energy into vacuum) and disappear for the researcher at all, at sometimes two packets are detected, as it were obtained from one, and the excess of energy is taken from vacuum. But the motion equations themselves know nothing about vacuum and are able to generate energy by their nature (they are non-invariant in respect to coordinates translations) and the laws of conservation so habitual for us do not exist for them.

Remind once again that the last result from Newton equations, and Newton equations appear at doings ample quantity averaging, and there are no laws of conservation for single events at small energies.

In other words philosophically speaking we can say that some motion being started at once in future will create other motions (energy) and, as a result, a substance. And as far the most various and giddy speculations are possible here, right up to Universe creation we are going to stop here.

Thus, according to our approach the generated or vanishing energy can be

manifested not only in changes of the particle velocity while a particle moving in any potential field, but also in appearing or disappearing of particles. The changes of the particle velocity in motion can be easily detected. In particular, the velocity increase can be used for the generation of both heat and electric current. May be there are power systems where the fact of charge oscillation and its effects are exploiting (see the following sections 3.4-3.11). Perhaps these phenomena, which are in conflict with the most fundamental laws of the modern science, were discovered long ago. Perhaps they are and even are used. But exactly these phenomena are easy to operate at the first stage of such new energy technologies development.

To develop such energy generation technology it is necessary to suppress the solutions of “Crematorium” type. But all quantum processes are based on elementary acts and each individual process is not a subject to separate control.

But if one controls the probabilities of such processes, they, being multiplied by the great number of process participants, automatically become macroscopic variables of quantum kinetics and the process become possible. That can be easily done by choosing the process members having correlated initial phases.

### **3.4 Review of Some Anomalous Phenomena Connected with Violation of Traditional Fundamental Laws**

*You see things that are and asking “Why?” As for me I’m imaging things that have not been yet and say “Why not?”*

*George Bernard Shaw*

In accordance with our theory, the conservation laws are not valid for the

single micro-particles, they appear after averaging over particles' ensemble only. Thus, if one were able to collect together all processes generating energy and suppress those ones with vanishing energy it would be able to obtain a classical «perpetuum mobile» (it has been already considered in details in section 3.2).

All this is particularly apparent in the problem of the oscillations of the harmonic oscillator, where four types of solutions can be obtained. Three of them are of the most importance for us: the stationary one, the “Crematorium” and “Maternity home”, traditional laws of conservation do not work in the two latter ones. Such behavior of the oscillator is able to explain most part of experimental data (we should remind that these solutions apparently take place not only within classical parabolic potential  $U(x) = \frac{kx^2}{2}$ , but within many other potentials too).

But the UQT and the equation with oscillating charge differ in many aspects not only from the classical mechanics equations but from some equations of electrostatics and electrodynamics also.

There is a fundamental theorem about circulation for electric field. Let us examine it more detail. Assume there is the vector's field (of electrostatic or gravitational character):

$$\mathbf{E} = P(x, y, z)\mathbf{i} + Q(x, y, z)\mathbf{j} + R(x, y, z)\mathbf{k}$$

Circuital integral

$$\Gamma = \oint (Pdx + Qdy + Rdz) = \oint \mathbf{E}d\mathbf{l} \quad (3.4.1)$$

is called the circulation of vector field  $\mathbf{E}$  round the closed contour (or path)  $l$ . Of course circulation depends not only on  $\mathbf{E}$ , but on the direction of integration along  $l$ ; the change of the tracing direction leads to the sign change. The form (3.4.1) is convenient for mathematicians, but for our purposes we will write (3.4.1) in

slightly differed form. If we multiply both parts of the equation (3.4.1) by the electrical charge  $q$  then we will obtain in the right part the integral of the force  $q\mathbf{E}$  along the path  $d\mathbf{l}$ , i.e. work necessary to move the charge along the closed contour. It is well known that its value is equal to zero.

$$\oint q\mathbf{E}d\mathbf{l} = 0 \quad (3.4.2)$$

If that value were not be equal to zero, the source of energy could be created. For this purpose it is necessary within the electric field  $\mathbf{E}$  to shift the charge from the point  $a$ , located in the area of high field strength, to the point  $b$ , where the field is weak, and then move it back to  $a$  along another path. The values of work of  $a \rightarrow b$  and of  $b \rightarrow a$  would be different and we would be able to derive work from the field without any changes of the system. When the charge is constant, no doubts it is true, that is why in the case of a macroscopic constant charge that theorem is some analogy with the energy conservation law. We have not met similar interpretation of the energy conservation law in other works. If the charge is microscopic, it changes, depends on time, coordinate and velocity, and effects produced at moving  $a \rightarrow b$  and from  $b \rightarrow a$  will be different. And then in principle it would be possible to extract work from the field without any additional changes in the system.

Furthermore now we have tunneling possibilities different from ones predicted by standard quantum mechanics, we have analyzed in sections 2.5. and 2.6. According to our approach the probability of tunneling depends on the phase of wave function. That will be used in further analysis.

Now we will describe and analyze some unusual experimental results, some unusual devices meant for laboratory or even industrial use. The authors of this book have nothing to do with these experiments and devices regarding many of

them with skepticism. The problem is that the sphere of new sources of energy – is a headache of the all-human civilization. The dividends in that can be high as nowhere else. So, surely, there could be a lot of swindlers (the last are even among theorists) and simply honesty mistaken persons in that field. The official science in the whole world do not believe to such researchers, but the most suspicious fact is the extraordinary number of such projects, and it is not out of place to list here the Russian (may be, not only Russian) saying “There is no smoke without fire”.

The fact is that an absolutely youthful sphere of power engineering has appearing nowadays. It is thriving on, a lot of new devices are appearing that differ substantial from the existing ordinary energy converter and generate additional energy, i.e. possess the efficiency more than 100%(!). The English term “overunity” has been specially invented for such devices.

In the USA such works are not officially supported by the state yet (unlike the problem of hot nuclear fusion), but a huge number of private companies and single businessmen are carrying out such researches. Special magazines involved in that problem have been established in the USA: Journal of «New Energy», «Infinite Energy», «Cold Fusion», «New Energy News», «Fusion Facts». In Russia the Journal “New Energy Technologies” (St. Petersburg, published in English and Russian) is established. Among the countries where the problems of new power engineering are studied quite seriously are Switzerland (where the Journal “NET-Journal” is published), Italy, Germany, France, Japan. Japanese researchers are in extremely earnest about these problems. It appeared that the most advanced country in the field of these problems research are not USA but Japan, the last is even financing many institutes within USA in the network of that problem. Japan total cost of research work is more than \$200.000.000 per year. We may forecast that at Japanese mentality and state policy aiming the

export not the minerals but the products of high technologies and intelligence, that country will be among leaders in the beginning of XXI century. In Russia such researches are also carrying out, but till now mainly on the base of personal enthusiasm.

Let enumerate some of interesting directions in new power engineering:

1. Patterson fuel element.
2. Super- magnet super-engines Tahahashi, Apsdent and Adams.
3. Swiss device Testatika.
4. Engines working on water.
5. Griggs hyper-sound pump, heat-generators of Potapov and Schaffer.
6. Cluster systems of Kenneth Shoulder and Hal Fox.
7. N – machines of Faraday, Bruce de Palma, Neumann, Searl, Tewari and others.
8. PAGD reactor of Canadian researches P&A Correa.
9. E-Cat Andrea Ross-Italy.

We should add the astonishing experimental results of A. Samgin and A. Baraboshkin (Russia, Institute of High-temperature Electro-Chemistry RAS, Ekaterinburg) [63, 64] and of T. Mizuno [65] (Japan). They have used, apparently independently one from each other, some special proton-conductive ceramics that is able to generate the thermal energy thousands time more than energy consumption if current runs through it. In some experiments of T. Mizuno that value exceeded 70000(!). In private talk with one of the authors T. Mizuno said that he was worried to get sick with radiation sickness due to exposure of radiation. However no  $\alpha, \beta, \gamma$  radiation or nucleus fragments were detected

and, consequently, nuclear processes (fusion) are not responsible for such energy liberation. Such proton-conductive (to be more correct – deuteron-conductive) ceramics was created with of a powder metallurgy method by agglomeration at high temperature. In other words all chemical processes had finished long ago. The origin of such a great quantity of excess energy is unexplainable in the framework of usual science, because it can not be explained either by nuclear or chemical reactions or by changes of phase. The authors of that experiment thought that reactions of nuclear fusion like D+D took place. At our request A. Samhyn exchanged deuterium for hydrogen in his experiments. If that great energy generation were had to do with nuclear D-D reactions all anomalous heat efficiency would disappear, but it remained valid. After so great energy emission the tablet went to powder.

These effects can be easily explained from the viewpoint of the harmonic oscillator theory. Caverns of hundreds Angstroem (units) appear in the tablet during agglomeration. While passing direct or alternative current, moving protons or deuterons (such ceramics contains few electrons) get into these caverns and there the processes described as “Maternity home” may start. The particle oscillates within the well taking the energy and in the long run that energy will be enough both for heating and for breaking the walls of the well (the tablet becomes powder). It seems that the same processes take place within palladium electrolytic cell containing heavy water and within nickel electrolytic cell with ordinary water.

It would be better if one experimentally tests the tunneling dependence on initial phase. But as it seems to us it would be more important for our critics as both cold nuclear fusion (CNF) and discovery of nuclear transmutations (from the modern science point of view the last is more nonsense than observations of CNF are) can not be apparently explained in any other way. Besides a lot of people and groups all



over the world believe of phenomenon of nuclear transmutations can be used for processing and utilization of radioactive wastes. Moreover, the question of industrial generation of tritium with the CNF technology from a military view is studied in Los-Alamos with the support of army. Magazines and Internet are full of such news. We are not going to place here Internet address, because everything is constantly changing in that lively system.

Let us analyze some of the above-mentioned devices.

The first and the most “ancient” and strange news were numerous information about internal-combustion engines working on water. Here we give one example only: when we were students one of our lectures the late Prof. G. V. Doudko (1959) told us that in 1951 he had participated in testing of internal-combustion engine [81]. The device was a hybrid of a diesel and a common carburetor engine. That device was started using a glass of petrol. Then the ignition was disconnected. Instead of fuel, pre-heated compressed water was supplied into the drum with a usual diesel fuel. Pump in drum was supplied water with some additives. (The inventor was adding them in the tank by himself, and it is clear now these additives were the main secret). The engine was placed at the boat. The inventors boated during two days in the Azov Sea. Engine exhaust consisted only of water vapor. The fuel was water. Prof. G. V. Doudko was scooping it himself from the sea and filling the tank. The engine required a lot of water, many buckets a day, but there was no lack of the water...The question why if it is so amazing these engines are not used, can be asked only by someone who has never lived in Russia.

The possible theoretical explanation of above can be given by solutions of the harmonic oscillator problem [58, 82-86]. Viz., if a highly compressed quantity of water with appropriate additives (namely these additives are the main secret) is injected into the drum, then each water drop starts to expand and passes owing to inertia the equilibrium position. In the result caverns (empty volumes) in few tens

of Angstrom each can appear inside. If a free proton gets into such cavern (or any other micro-particle) with an appropriate phase (we assume that such phase is owing, namely, to additives), then as a realization of “Maternity Home” solution some of the drops will blow up...Many times we have heard and read about Russian inventors created and successfully tested engines working on water with some secret additions.

Of course we can not totally avoid the probability of water catalytic decomposition with low energy inputs in the drum. All this is examined in details in sections 4.2.-4.4. Such energy sources would be absolutely pollution-free, and the only limitation would be the heat pollution of the environment.

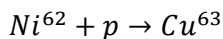
The ideal solution for the motor transport would be use of some new types of electric energy generators also. UQT assume even the possibility of such systems, many times experimentally studied both by Nicola Tesla and Canadian physicians Correa, who have even patented the system, generating electric current by taking the energy, as they thought, from vacuum fluctuations [87, 88]. The readers have the possibility to acquaint themselves with our detailed theory of these processes in paragraph 3.5. Besides the ideal system for motorcar would be, of course, Testatika.

The thermal cell CETI (created by James Patterson in 1995 [66]), using electrolyze of specially manufactured nickel bolts in common water, has shocked scientists in USA. American newspaper «Fortean Times» No 85, 1995, wrote about it: “December the 4th, 1995 will go down to history!” At that day the group of independent experts from five American Universities tested the work of new energy source with stable output heat rating 1.3 kWatt. The electric energy input was 960 times less.” All experts noted that generated heat had enigmatic origin and would be explained neither by chemical or nuclear reactions nor by phase transitions. By American ABC TV there were two telecasts at 7th and 8th of

February, 1996 in cycles «Nightline» and «Good Morning America» about Patterson creation of new source of energy, able to generate in hundred times more energy than it had consumed. And again it were accentuated that the origin of generated heat remains mysterious. It is interesting that American Company Motorola made attempts to buy the patent for cell CETI for US\$ 20.000.000, but was rejected. We are sure that Motorola Company had spent a certain sum for the study of that problem before making so serious an offer. All processes within the Patterson cell do not concern nuclear reactions (although Patterson thinks otherwise), and at our opinion can be explained with the same processes used here above for the description of proton-conductive ceramics.

Experiments of Andera Rossi at his E-Cat have agitated the Europe. It's difficult to falsify any generation of energy at the level of 1 MWatt. We cannot make the final assessment of these processes because of the absence of the most important details, and we cannot find anything apart some articles in the internet. By fragmentary information the E-Cat looks like a ceramic tube with conventional Nickel powder filled under pressure with Hydrogen. The heat (thousand times more than in any chemical reaction being processed in the same volume) is generated during very long period if current runs through the tube, so 1 watt of electric energy input generates 4-5 watt of thermal energy (in fact the energy totally can be transferred into the heat). Experts who repeated that experiment in Sweden and Switzerland with no doubt insist that great excess heat is existing, but the principle of what is going on is absolutely unclear due to the absence of any radiation. The analysis of rest Nickel powder shows the presence of Cupper. For complete understanding of the principles of the running processes it would be better to see the microscopic photos of the powder before and after experiment. Nevertheless we can make some simple conclusions on the basis of UQT.

First: there is a nuclear reaction



impossible in general quantum theory, but reasonable in UQT. By laws of general nuclear physics basing on mass numbers transformation this reaction is endothermic, i.e. no energy can be generated. According to UQT it is an absolutely new type of nuclear transmutation where proton of very low energy penetrates inside the nucleus. It is like a tunnel effect: one stable nucleus transforms into another stable nucleus with no energy generation, this phenomenon is described in details in section 3.1.

Second: It seems that the nature of heat relates to the processes obeyed by solutions of “Maternity Home”. Proton or any other free atom (it can be even a nickel) gets in cavern in a grain of Nickel powder (this processes requires certain size of caverns) and then heat is generated by realization of “Maternity Home” solution. The process is described in 3.3. There are a lot of such examples above. By the way nuclear transmutation has nothing with heat generation even in classical experiments because the volume of the nuclear reaction products is not enough for the observed thermal effects always. The time will dot the i's and cross the t's in these processes.

The phenomenon of sonoluminescence looks absolutely darkly too. According to it some liquids begin to glow when a weak ultrasound passes through them. That experimentally established phenomenon was discovered by Professor of Moscow University S. N. Rghevkin in 1933. It still has no satisfactory explanation. As the Nobel Prize laureate Prof. Julian Schwinger said, “*it did not have the right for being but existed*” [90]. And again it can be explained from the above-mentioned viewpoint of UQT.

Moreover, there are heat generators (Yu. Potapov [60-62, 91], (\*) - Moldova, James J. Griggs [68], Huffman T. [69], - USA and other). Inside of these generators the forced circulation of usual water takes place getting warmed during this process while the intensity of the water heating corresponds (if taking into account all energy expenses) to efficiency 150-200% and more. The cause of such heating is unexplained within the standard quantum theory and no question about any chemical or nuclear reactions arise.

It is possible to explain the principle of the functioning of such generators within UQT. The fact is that in the water flow inside of generators a lot of cavitations bubbles are created. That is made either by the water flow interrupt with a special rotor (J. Griggs, Huffman, Schaffer), or by swirl jet with a special elbow with further getting into the abrupt enlargement zone where cavitation bubbles are appearing (Yu. Potapov). It should be said that in general even now the cavitation is a great mystery for theoretical hydrodynamics and science at all. For example, forged large-tonnage screw propeller of huge nuclear-powered submarines may be destroyed in few hours only due to cavitation, with appropriate work conditions and geometry of surrounding forms. That takes place because of huge energy to be generated in cavitating bubbles. Viz., the behavior of particles inside of the bubbles may be describes by our solutions of the harmonic oscillator's problem. According to these solutions, any particle getting inside of the bubble will oscillate between inner walls of the bubble. The velocity of particle having certain values of the phase will increase after each reflection from the wall, and after numerous reflections the particle will gather energy big enough to destruct the bubble. In the long run the oscillations energy of such a particle gathered inside the bubbles is usually transformed into heat or

---

(\*) Notice that more over thousands of Yu. Potapov generators are produced to-day and used for houses' heating.

bremsstrahlung which destructs bubble. That physical idea is able at once explain the sonoluminescence (in general, in the case of the sonoluminescence that process looks not so primitive) and the energy liberation in proton-conductive ceramics (the caverns instead of the bubbles play the same role), in the nickel during the process of electrolysis in common water (CETI cell), in water bubbles in heat-generators. The theory suggests that samples should crack due to the increase of pressure on the walls of potential well, that is already because ceramic samples as well as nickel balls within CETI cell get into powder in the end. Apparently because of that fact any metal containing in its lattice many hydrogen atoms becomes brittle and falls apart in a short time. That phenomenon is well known to engineers.

Due to the not enough quantity of the experiments carried out it can not be specified now what particles are generating into the potential well (micro-bubbles). Besides for even electron escape the depth of potential well should be about 0.5 MeV, in solids the depth of potential wells is about few eV, and here apparently kinetic energy overflow is realized only. That fact that such a process requires extremely deep potential wells, and such conditions do not exist in solids, changes nothing.

Of course in general terms both competitive processes “Maternity home” and “Crematorium” take place, and they are compensating each other saving energy. At energy liberation “Maternity home” solution should prevail. Both processes take place at the same time and compete with each other, but formally they are not joined in space or time. The problem complexity of energy generation is in knowingly optimization of parameters to suppress “Crematorium” solution and promote realization of “Maternity home” solution. Nowadays nothing can be said exactly about either optimal dimensions of cavitating bubbles in heat-generators or type of the object oscillating within them, because it requires special

experiments that have not been carried out yet.

Of course in the way of the transformation of the heat obtained at heat-generator or ceramics into electric or mechanical power there is an implacable Robber in the form of Sadi Carnot principle. According to that principle it is possible to transfer electric or mechanical energy in the whole into the heat but reverse processes is followed with great leakage.

If there are experiments where energy liberation conflicting with the general laws of conservation have been detected, then the opposite experimental data should exist according to which energy vanishes, i.e. the “Crematorium” process prevails. And it turned out so. There are so conditions at the process of electrolysis within electrolytic tank, when temperature of the solution within tank by no evident reasons noticeably decreases. That phenomenon has been detected many times ago by engineers in industry and is called “baths freezing” [93, 94]. In his experiments [92] Chinese physician Swe- Kai-Chen (Taiwan) has steadily studied the same phenomena. The explanation is quite evident; a particle with the velocity higher than the most probable one within the given distribution gets into caverns of electrodes. After few oscillations it decelerates, its velocity becomes less than the most probable one and the particle leaves cavern with low velocity. Then the same process may occur with another energetic particle. If there are many such events, it results in cell freezing.

The problem of ferromagnet switching (Ising model) may be also reduced to magnetic dipole orientation by external magnetic field. And then it is basically a harmonic oscillator equation with a slightly different returning power ( $F = \frac{\mu}{r^3}$ ) and any conclusion obtained in the section 2.8. remains valid. So switching process effects of energy liberation should also take place. It turned out so. For the general public everything began at the 17th of May, 1996, when Frode Olsen

form scientific group “Free Energy” showed at Norwegian television (TV2) film surprising everybody about “dynamic sculpture”, made by artist and sculptor Reidar Finsrud from Skaarer, Norway. The creator of that “dynamic sculpture” had no idea about physics he had build his sculpture over 12 years. Now it is a perfect time to recollect the A. Einstein idea about how the discoveries are made: *“everybody knows that this or that things are utterly impossible, but once a person appears who knows nothing about it. And he invents it”*.

That “dynamic sculpture” has an explanatory label «perpetuum mobile» attached to it. It is a thoroughly polished iron ball 2.7 inches in diameter and weighing about 2 pounds. The ball circles along two parallel skids 25 inches in diameter. On its way it passes three constant magnets. Near the magnets there are three additional mobile magnets placed at special mobile levers, each 5 inches long. While the ball is rolling by these mobile magnets, they incline slightly (due to the ball attraction) and after the ball has passed, they are lifted by hold-out springs (rock like a cross-beam). The ball completes a revolution in 3 seconds. They claim that the ball had been circling more than a year (!)

That magical device, which does not have any energy sources, is placed for universal observation viewing in picture-gallery (Norway). It stands on a special pedestal and covered with bell-glass. The authors only saw a perfect film about that device and were most surprised by fact that the ball had not stopped during the shooting of the movie (approximately 20 minutes). We are quite familiar with conjuring tricks but it is beyond our understanding how that trick could be performed even with the help of some secrets. It could be clearly seen that while moving the ball always transferred part of its energy to the three long swinging pendulums, but they could not be in any case used for the ball jog and friction compensation, the only fraudulent idea that could be realized here. All other details were clearly seen and did not contain anything suspicious.



Let us estimate generated energy. At initial velocity about 1 m/sec. the ball would stop after 30 seconds, if all magnets were taken away. That means that energy consumption within 30 seconds is approximately 0.5 Watt-second or 1/60 Watt. The total energy generated during the month equals 43200 Watt-second. But that enormous energy is much bigger than the energy of a good shell!

It is understandable (if this word is appropriate here at all) that when the ball approaches to the constant magnet and is magnetizing it accelerates. But when it leaves the equilibrium position and moves away, it becomes demagnetized. So the attraction power (now it starts to slow the ball down) is a little bit less than it was at the moments of ball acceleration. That small difference of forces guarantees some positive work of friction compensation. That had been predicted by one of the authors in journals *Infinite Energy* vol.1, No.2, p.38, (1995); *Proceedings of the ICCF5*, p.361, April 9-13, (1995), Monte-Carlo; *Cold Fusion*, No 11, p.10, (1995); *Chinese Journal of Nuclear Physics* (vol.19, №2, 1997). The quantum-mechanical processes that take place are especially complicated, but some questions are understandable.

Of course, all advanced thinking physics understood that at once. In France J. Naudin in a short time staged a similar but a much simpler experiment. The ball of magneto-soft metal rolls along exclusive U-guides inside a system of four magnets. There is a small fade step near the U-bottom. Apparently, it was made especially to make the duration of magnetization and demagnetization processes different, and that is quite essential. If there are no magnets, nothing interesting would happen and oscillations relax rapidly (just in few seconds). If there are magnets, then the oscillations continue up to 3 hours 27 minutes. It seems that in this case the experimenter has not managed to find a better material for the ball and better device parameters. Therefore an imperfect compensation of friction

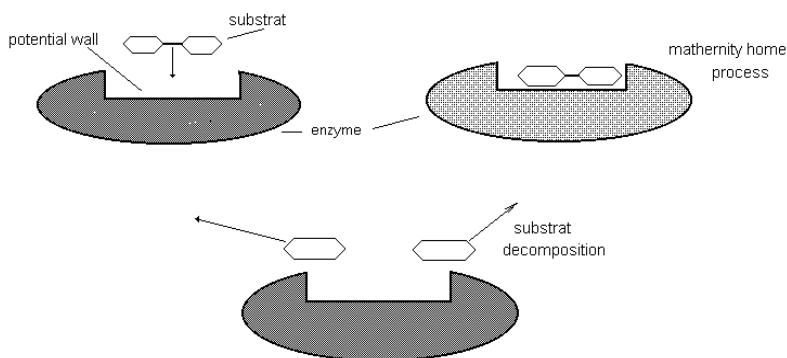
forces takes place. And during all experiments constant magnets have not become demagnetized, as the experiment has been repeated many times with the same results.

And now we would like to say few vague words about the processes of switching. At the process of the ball magnetization its atoms are oriented along the field lines (as an arrow of compass). When ball leaves the area of magnetic field, atom's magnetic moments are disoriented under the influence of thermal motion and ball becomes demagnetized. According to Unitary Quantum Theory the part of the oriented magnetic moments may be more ("Maternity home") than it is predicted by standard quantum mechanics, and so the ball's attraction power may be more too. As for the disorientation of these moments, they are approximately similar in both theories. The magnetic forces during the ball's getting close to and moving away from the magnet apparently differ both for this reason and because of the difference in times of switching and demagnetization.

Then (or independently?) Greg Watson, President of Microtronics Company from Adelaide (Australia) promised to produce similar toys in small series at price \$150 per unit. It was announced in advertisements that money would be immediately returned if toys were not working. The company plans to arrange mass production of so toys, and when its number will prevail some critical value, then would be possible to speak about the most solemn funeral of the conservation laws.

The scientists of older generation can recollect that in 30-ties similar toy was shown to David Hilbert, and he said it was the most interesting thing he had ever seen. There is the question, why it has not been realized jet? We do not know a physic-mathematical answer for that question, and the analysis of social reasons is out of the area of our investigations. The Japanese have another mentality; there is a special state program to generated energy from constant magnets in

Japan. And Tahahashi [95], probably, has created electric motor with the efficiency to 318%! The well known problem of “shortage” of energy in many biochemical reactions with the ferments (enzymes) participation looks even more mysterious. For example, in the deeply studied reaction of polysaccharides disintegration in presence of lysozyme the following take place: a molecule of polysaccharide appears in a special cavern in a big molecule of lysozyme, sole time later its debris is thrown out (Fig. 3.4.1)



**Fig. 3.4.1** *Disintegration of polysaccharides molecule in presence of lysozyme.*

The energy of broken bound in polysaccharides is about 3 eV, and the energy of thermal motion is 0.025 eV only. So it is absolutely incomprehensible where the lysozyme takes energy necessary to break polysaccharide from. There is no any satisfactory mechanism to explain this type of reaction (although they are a lot of the explanation). As physics say, “the problem was pigeonholed”.

The most astonishing is the fact that in all excess energy liberation can not be explained by chemical reactions or changes of phase. If sometimes nuclear reactions take place (in accordance with modern science that could not be at all) they are able to explain a hundredth or a thousandth part of the heat energy liberated. There is no doubt that all these facts belong to the new physical theory,

because there are no any reasonable explanations for these facts in the network of the old theory at all. The problem of catalytic process is described more detailed further in the sections 4.1-4.4.

But the existence of a devise able to generate from nothing about 10 kilowatt of electric energy in direct current with voltage 300 V seems nearly incredible. One of the authors wrote about that in 3 different journals and here we give only a summary of it [96-98].

In summer 1999 one of the authors visited some scientific-research organizations with an invitation of Switzerland physicist (Adolph Schneider, the Director of the Institute of New Energy Sources in Egerkingen). It is interesting that small Switzerland have such an institute and big Russia have not. The purpose of the invitation was quite simple: just to explain the work of one device generating energy from nothing, i.e. “perpetuum mobile”. In Switzerland these devices are called Testatik Machine M/L Converter from religious group «Methernitha» (Address: Methernitha, CH-3517 Linden, Switzerland, phone: ++41 31 97 11 24).

Such machines are working now in Switzerland in the small town Linden near Bern. A part of that town belongs to a Religious Christian Community, enclosed and thoroughly guarded. Commune contain about 250 members, most of them are physicists, graduated from Geneva, Lausanne and Bern Universities. That is not research Laboratory only; they have their own TV center, film studio, small furniture production, workshops, garages, living houses and other services. As you have perhaps have already guessed that community do not consume any energy. That fact is the most exact in that story, as the community does not receive bills from the electric power station supplying electricity to the town. Meticulous reporters cleared up that fact. They just have in the cellar of one of their houses their own electric power station that generates energy ... from

nothing. The inventor of so inexhaustible free energy source of the direct current Swiss physicist Paul Baumann (from other sources he is a watchmaker) created his first sample in a Swiss prison, where he has spent over 20 (!) years. Unfortunately we could not clarify how did he managed to get that not best place for creative work place, may be it was due to our bad knowledge of English.

Note, that it is not a unique case when great discoveries were made in prison. And Russia, of course goes ahead of all. For example, the Russian mathematician M. V. Ostrogradsky proved a theorem (now it is called Ostrogradsky-Gauss Theorem) in Saint-Petersburg debtor's prison, where he was canded for big loss in cards he was not able to pay out. It is curious that in this building on Fontanka Street is now the Petersburg University of Fine Mechanics and Optic. But more curious is the following circumstance: having proved that theorem he sent it in Paris to the French Academy. He received a replay from famous mathematicians O. L. Cauchy who highly evaluated these investigations and published the article in the Comtes Rendues of the French Academy. Frankly speaking, in his letter to M. V. Ostrogradsky he expressed his astonishment that such a gifted person worked in prison. Ostrogradsky answered that he was not working but was imprisoned for cards' debts. Cauchy was a rich man and paid Ostrogradsky's debt...

Let us briefly describe these fantastic devices: they are created in four types (sizes) with the power equal to 0.1, 0.3, 3.0 and 10.0 KWatt. The device looks like a standard electrostatic machine with Leyden jars, which is widely used in physical demonstrations. It has two revolving in opposite sides acrylic disks with 36 narrow aluminum sectors attached to them. First samples were made of gramophone records. The machine is started pushing the disks in opposite directions with a finger. Speed of rotation is 50-70 revolutions per minute. After being started disks are rotating spontaneously and can be easily stopped with a

finger. The voltage of direct current output is about 300-350 V, the current is up to 30 A. The mechanical energy required for revolving (according to measuring of Prof. Marinov is about 100 mWatt only) is hundreds times less than electric energy output. The biggest device with the output of 10 KWatt has plastic disks more than 2 meters in diameter (Fig. 3.4.2.), and the smallest – 20 sm. only. The device weight is quite small, because the machine with the 3 KWatt output weight about 20 kg.



*Fig. 3.4.2 Device with electrical power 10 KWt.*

The process of charges separation (that also requires energy!) almost does not brake the disks. Connection of an additional load in the form of 200-Watt lamp does not change the revolving rate too. Neither cooling nor heating of the air or machine's parts during long-term work arise, only light aroma of ozone is smelled. Such a system is noiseless, compact and environmentally appropriate, it can be installed everywhere.

The Community leaders justly suppose that mass distribution of such systems all over the world would result in a thermal explosion, because in the long run the energy generated by humanity is collected on the energetic dump (it is transformed into heat) and as a result leads to the environment overheating. They do not believe (and not groundlessly) in the humanity's ability to agree about the rational use of the discovery. They suppose it can be more dangerous, than nuclear, bacteriological or general weapons. Their main request to the Humanity is to live in balance with environment and to fully utilize the energy of wind, sun, water and so on. That is why everything in that Community is thoroughly guarded and unauthorized people have no access there And for these reasons they are not going to put main discovery at the disposal of the humanity.

And further we have a real detective story: an Austrian physicist from Institute of Fundamental Physics in Grats (specialist in electrodynamics) Prof. Stefan Marinov had visited the Commune twice (at July 1988 and February-March 1989). He was presented with such a device with the output of 100 Watt (300V, 0.3 A), and he studied it in his Laboratory. As we know now the inventor himself does not fully understand the principle of his machine operation. So he has contacted Marinov just out of the scientific curiosity.

In 1989 Prof. Marinov published his book "Thorny path to the truth – documentary confirmation of laws of conservation violation" with International Publishers East-West Co. That book contained a number of photos, measurements report, and device description. He established a scientific-research group "Free Energy" (Methernitha Group Stefan Marinov Free Energy) in the community. That book contains quite astonishing words:

*"I can confirm without any doubts: that machine is unadulterated classical perpetuum mobile. After initial push being imported it continues revolving arbitrarily long without any assistance and generating electric power in the*

*value of 100 watt... In that device engine and generator, separating the charges, are combined... However it is still vague how it could happen..."*

As we know, nobody managed to create similar device anywhere else.

In 1995 one of the authors of the book read the paper "About mechanism of energy generation in unitary quantum theory" at International Conferences on Cold Nuclear Fusion in Monte-Carlo. In October of 1996 in Japan he read the report "Energy generation in Schroedinger equation solutions". Then in April 1997 Professor Stefan Marinov called him up and they agreed about the author's visit to the Graz Institute of Fundamental Physics. But on the July 15th, 1997 Prof. Stefan Marinov was thrown out of the university library window in Graz by unknown people. He died carrying away a lot of secrets. Any good detective would evolve further a theory about these unknown persons were acted on behalf of coal, oil, electric power or gas companies, and poor religious Commune had nothing to do with it. But the authors have a firm aversion to detective stories...

Modern times are taught, and we can explain why it is happened. It is widely known that the great Serbian Nikola Tesla developed in the USA similar source of energy. When Morgan, who financed his project, got known that Tesla was creating an inexhaustible energy source and was quite near to solution, he immediately stopped financing and prohibited further investigations. Morgan considered that such source of energy would make independent a lot of people and they would become hardly governed... and nevertheless N. Tesla died a natural death...

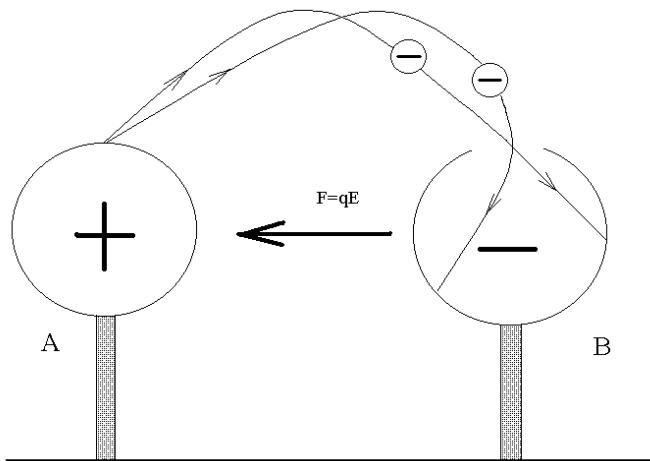
In gloomy Middle Ages such persons were simply faggoted, at socialism in Russia out of humanity considerations they were not published, those people were quasi not existing, now in the west they are thrown out of the library windows. Some progress with oscillating character is on hand, and really momentary death is better than medieval tradition of faggoting...Further the



readers can draw parallel by themselves and think who is in advantages.

As for us, we are coming back to Egerkingen. First Swiss party agreed with Community about our visit together with one acquainted physicist from Bern University. Exactly at that time in Community there should be an anniversary meeting of some Bern University graduates. But at the last moment we were kept out Community, as for our acquainted physicist (now he is a lecturer of physics in Bern University) he spent there the whole day. For consolation we had to ascend a hill to have a look at Community from the car window. Really we could see at Community territory besides numerous buildings and laboratory with transparent «Methernitha» there were one small wind turbine and small water wheel. Most likely the total energy generated by those sources was not exceeded 2-5 kWatt.

Next day after his visit to the Community we were able to talk with our physicist at his home. We learned a lot of interesting things. He looked quite confused mentally, his hands trembled. In Russia we say in such a cases that, “he was, as it were, hit by dusty bag” [176].



**Fig. 3.4.3** Work for transferring the charge depends on themode of transferring and on the path.

We are just going to show that existence of so device is in harmony with UQT. It is natural that machine works on the principle of charges separation. Assume there are two metal spherical surfaces with a hole isolated from Earth and from each other. If we transfer with the help of isolated stick the first charge from sphere A to the internal surface of sphere B through the hole, then the voltage will appear. And if we transfer the second and further charges, sphere A will attract transferred charge and sphere B will repel it. And for all these we will need energy for the charges transfer. (Fig. 3.4.3).

Recall that in accordance with the present circulation theorem all this is impossible. The energy used for the charge transferring would be equal to the liberated one. But in the UQT the circulation theorem for the single elementary charge (equation 3.4.2.) does not work. So we are able to choose such time and way that if the second charge is transferred along them, then the value of the field will be near zero, and therefore the electrostatic power will be near zero and of course the same will be true for the work of the charges' transferring and separation. For example, we choose not the way but wait the moment when charge reduces to zero and then rapidly displace it, and stop that process when the charge appears. One may choose appropriate way and velocity. There are a lot of variants. Probably Paul Baumann has realized exactly that way, but till now he is nearly unknown for official science. Today he may be consoled by the fact wheel inventor will never be known. The problem how to implement it technically is an engineering question.

And totally impossible looks the sensational story of curling and flying disk Searl (see Internet), that can be also explained but we are not going to do it just now.

One can not help wondering whether all that is not just a trick? First of all, if everybody always will believe in energy conservation law firmness, there would

be no progress in that question, and moreover it is totally out of understanding how could the humanity come down from palm tree. Second, to excuse the rebellious point of view offered we can say that if the authors were told 30 years ago (they were professors already) that in the beginning of next millennium they would write such a book, they would have thought that not only the most fool joke, but something absolutely impossible. But as Voltaire said: *“The fool is, who does not change”*.

It will be a mistake to think that modern quantum theories do not contain paradoxical theoretical questions and examples. We have already written above (section 1.3) about some paradox connected with Dirac equations.

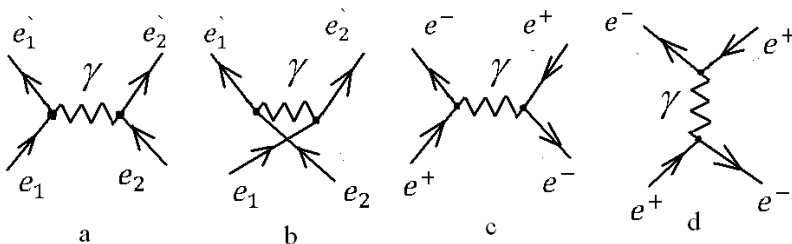
Let examine now some simple cases. In solutions of Schroedinger equation for harmonic oscillator there are such cases when the  $\Psi$ -function of the particle equals zero. Nobody knows how a particle oscillating in parabolic well manages to pass through those points. The answer that a particle does not have a definite trajectory makes little clearer. A similar situation appears in hydrogen atom s-state, when, for example, in 2s –state electron clouds of the electron’s  $\Psi$ -function are divided by a closed spherical surface where the  $\Psi$ -function equals zero. And how does the electron managed to get from one cloud to another?

R. Feynman was the only physicist who said about quantum theory *“the quantum world relates with that strange peculiarity of nature that is contradictory to common sense”*.

Today quantum electrodynamics gives the most exact among other sciences mathematical description of nature. For example, abnormal magnetic moment is evaluated with especially high accuracy, 12 fugues of which coincide with experimental data. There is no any other exact science that has been examined

with so high accuracy. The same Feynman writes: “*Quantum electrodynamics gives totally absurd, from the common sense point of view, description of Nature. But it absolutely coincides to experimental data... Physicists have realized that it has no matter whether they like any theory or not. The other point is more important: whether the theory is able to predict results that coincide with the experiment. It does not matter whether a theory is good or not from philosophical point of view, whether or not is it easy for understand, whether or not it is flawless from the position of common sense... Physicists gave up, they are not searching for any physical sense in quantum science... we leave alone the question about why the Nature was arranged in such a way and not in other...*”

The most evident of absurd in quantum electrodynamics, from the common sense point of view, is, for example, the presence of two types of particles. One transfer momentum only, but does not carry energy, the others on the contrary transfer energy but do not carry momentum. As far that problem has not examined jet under that point of view in different modern serious monographs concerned to electrodynamics let examine that phenomenon in details and may be we will be able to reduce it to that awful paradoxically. Let examine that process of electron scattering at electrons (Moller dispersion) electron dispersion at positrons (Bhabha dispersion) [99]. Feynman diagrams for such processes  $e^-e^- \rightarrow e^-e^-$  and  $e^+e^- \rightarrow e^+e^-$  are shown at Fig. 3.4.4.



**Fig. 3.4.4** Diagrams for scattering processes  $e^-e^- \rightarrow e^-e^-$   $e^+e^- \rightarrow e^+e^-$ .

Both electrons in scattering  $e^-e^- \rightarrow e^-e^-$  are indistinguishable and so both diagrams a and b should be considered simultaneously. As it is impossible to say what process a or b takes place in reality amplitudes but not density is to be summed up.

Both particles at dispersion  $e^+e^- \rightarrow e^+e^-$  differ from each other by electrical charge, but again we can not say what process c or d occurs and again amplitudes of both process is to be summed up. Contribution of c process is called contribution of photon exchange; contribution of d process is called annihilation contribution. Let examine the last one in details. The contribution arises because quantum numbers of electron-positron pair are equal to quantum numbers of photons, viz:

$$A = q = S = L = L_{\mu} = 0.$$

It is clear that once virtual photon has appeared it “forgets” everything about generated process and may cause the whole line of the following reactions:

$$e^-e^+ \rightarrow e^-e^+, 2\gamma, \mu^+\mu^-, \pi^+\pi^-, \pi^+\pi^-\pi^0, K^+K^-, pp, nn \dots$$

Only first three processes deal with the electromagnetic coupling, the first of them is presented at Fig. 3.4.4c.

For counter-current electron packets both angular dependence of effective cross-sections and their absolute values were measured. To reduce Rutherford dispersion at target nucleus a special method was used (positioning of counters under special angular and match circuits). The results of experiment and theoretical calculation match perfectly. But what is the price?!

For that purpose let us study in details diagrams c and d. Virtual photons at

exchange diagram c and annihilation diagram d appeared to be totally different. Both photons are virtual and do not comply general correlation for the energy  $E=pc$ . Let examine both perfect processes within the center-of-mass system. For the exchange diagram c incoming and outgoing electrons obtain similar energy and opposite momentum. So energy and momentum of virtual photon are equivalent to:

$$E_\gamma = E_e - E'_e = 0$$

$$\mathbf{p}_\gamma = \mathbf{p}_e - \mathbf{p}'_e = 2\mathbf{p}_e$$

If we determine the virtual photon mass with the help of the relation

$$E = \sqrt{p^2 c^2 + m^2 c^4},$$

then we will get

$$m^2 c^4 = -(2p_e c)^2 < 0$$

In other words that virtual photon transfers momentum only, and does not carry any energy. The square of its mass is a negative value and is called space-like. The origin of such a name comes from special theory of relativity. According to that theory it is a four-dimensional vector for which the square of its temporal component is less than the sum of its space components' squares. If any physical value appears to be a space-like vector, then an inertial reference system where time component vanishes always exists. If at any point of space spatial distance between two points is under consideration, in initial system to be moving relative to initial distance four-dimensional vector will be transferred in space-like vector with time component.

For the annihilation diagram d we have inverse situation. Its energy is:

$$E_\gamma = E_{e^-} + E_{e^+} = 2E,$$

and momentum will be:

$$\mathbf{p}_\gamma = \mathbf{p}_{e^-} + \mathbf{p}_{e^+} = 0.$$

That virtual photon transfers energy only and does not carry any momentum. The square of its mass is

$$m^2 c^4 = -(2E)^2 > 0$$

positive value, and the photon itself is called time-like. Any four-dimensional vector according to special theory of relativity the square of temporal component is more than the sum of its space components' squares is time like. The square of four-dimensional length of time like vector is negative figure:

$$\sum_{i=1}^4 A_i^2 < 0$$

if  $A_\alpha (\alpha = 1, 2, 3)$  are space components,  $A_4 = i|A_4|$  is time component. There is so inertial reference system, where space components of given time like vector in  $A'_1, A'_2, A'_3$  are equal to zero and, consequently,

$$A_i'^2 = \sum_{i=1}^4 A_i^2.$$

Such important for relativistic mechanics values of mass point as four-velocity  $u_i$ , four-momentum  $p_i$  are time like vectors:

$$u_i^2 = -1, \quad p_i^2 = -m^2 c^2.$$

The square of the length of vector connecting two world points (two events) to be taken with reversed sign is square of interval. So interval will be time like vector if square of interval is positive. Recollect, that if two events are connected

with each other or may be connected by causal relationship, the vector connecting them will be time like.

Thus in electron-positron dispersion the part two such wild, from the common sense point of view, particles. Of course it looks awful and everybody tries to forget about that. That is why physical reasoning is nearly absent in books concerned with quantum theory, they are substituted for bare mathematics able to make correct theoretical forecasts and matches experimental data. We are acquainted with the work of Hans Frauenfelder and Ernest M. Henley "Subatomic Physics", the only book [99] where the authors had courage to speak about this in quite direct expressions.

To our regret we are not ready exactly to simulate a situation with the help of our equations because the exact form of the wave packet for an electron is not known yet. Nowadays an electron and a positron are considered as point particles, but a packet like a Coulomb potential is hardly physically possible due to divergence at zero. Nevertheless, we are going to understand that strange processes from the most general positions, or in any case to get rid of anguish. For that assume that near zero electron structure looks like a Hamada-Johnstone potential, i.e. an electron center is surrounded by a potential barrier.

Assume the particle is flying the barrier in such a phase when the packet is small. At small amplitude equations become linear and the packet passes the barrier maximum without any momentum transmittance. But now after passing the barrier maximum its velocity may be extremely small, it can nearly stop and thus contributes to the amplitude (energy) of the electron's wave packet. It is a process with energy transfer but without momentum.

Another situation may occur when the packet approaches the barrier in such a phase that becomes reflected without momentum changing, but the momentum is



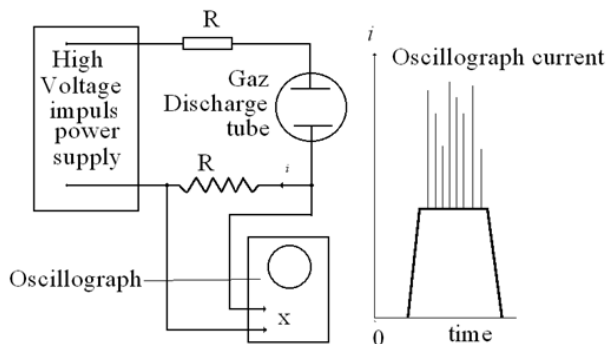
transferred to the scattering center. That is a process with momentum transfer but without energy. Similar processes have been illustrated above in sections 2.4 - 2.11 and 3.1 - 3.3. Of course all these are corollaries of absence of conservation laws in single processes with small energies.

### 3.5 Anomalous Phenomena in Gas-discharge and Possible Energy Sources (Pulsed Abnormal Glow Discharge-PAGD)

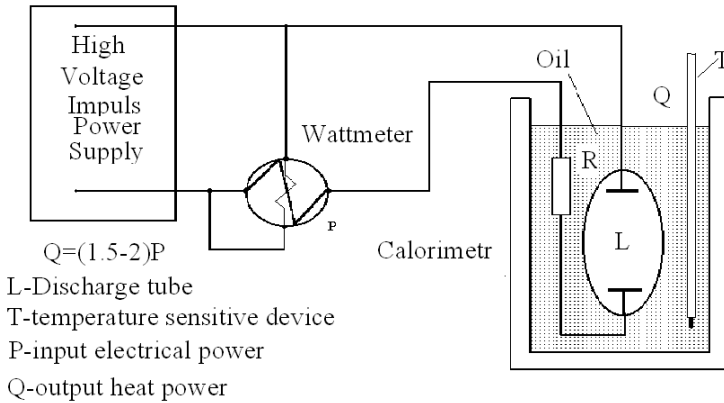
*There is a hint, but tail is lie,  
Perfect lesson for a guy.*

*A. S. Pushkin*

Fantastic phenomena at certain gas discharge regimes (the anomalous gas discharge close to the arc regime) were discovered as far back as 1929 by Nicolas Tesla [100]. It was discovered that due to some unknown reason within a powerful pulse gas discharge in the course of one pulse a lot of extremely short current spikes occur (see Fig. 3.5.1).



**Fig. 3.5.1** The scheme of the electric measurements.



**Fig. 3.5.2** *The scheme of the heat measurements.*

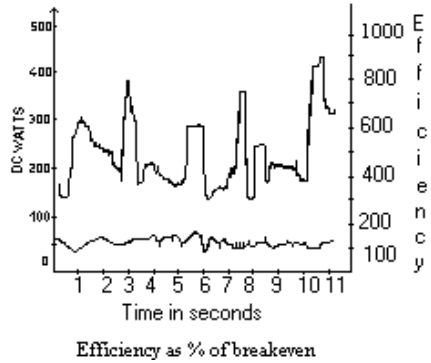
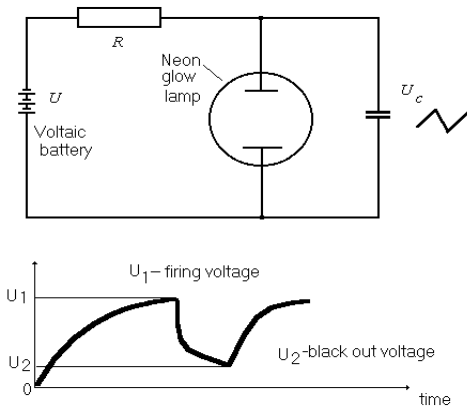
According to Tesla's estimation the energy resulting from these spikes exceeded the energy of the applied electric pulse. This fact did not attract much attention at that time, because it contradicted the existed physical ideas. Tandberg was the next [101] to discover this phenomenon but he had connected it to some mysterious processes taking place in the cathode. He had staged a number of experiments but did not manage to elucidate the nature of the phenomenon.

Later Prof. A. V. Chernetsky [103] (as well as Manfred Fon Ardenne, - Germany physicist (a privet communication)) performed some calorimetric measurements in a deuterium-lithium discharge (see Fig. 3.5.2). It was turned out that the heat generated in a jug with plasma appeared to be 1.5-2 times greater than the applied energy. Chernetsky had associated this excess heat with nuclear reactions allegedly taking place in the deuterium-lithium plasma, but neither neutrons, nor tritium was discovered, though these products were expected to be found in abundance.

Later on Dr. Wilhelm Reich in America [102] and P. &A. Correa in Canada had built a prototype of reactor, which generated excess pulse electric current. Except operating the tubes at a lower pressure, the Correas' claims seem to stem

from a tube design based on Reich's work. However, it is necessary to see Reich's actual drawings in the article "The Geiger Muller Effect of the Orgone", 1947, published in the "Oranur Experiment," or to see the actual tubes in the Wilhelm Reich museum before coming to that conclusion. We do not remember any mention of Reich in the Correa's patents. That possibly can invalidate the patents, even though the operation in the (lower) PAGD specified pressure range may (or may not) be considered by an examiner a novel invention over Reich's work.

Unless Marett [privet communication] lies, Correas certainly knew about Reich's tube, because Marett claimed to work with the Paulo Correa on replicating it in the mid-1980's. If this is true, Correas cannot hide behind his ignorance as an excuse for failing to mention Reich in the references to prior state of the art. All this could make defense of the Correas' patent very difficult at least. It appears possible the invention could even end up being public domain for all practical purposes.



**Fig. 3.5.3** The Generator on neon lamp. **Fig. 3.5.4** Generation of the energy.

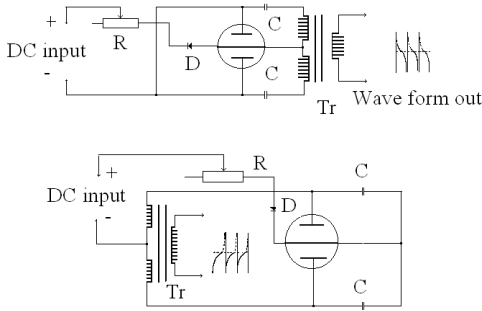
This is not a meant to comment Reich either positively or negatively, but only Marett's allegations of the Correas' lack of candor. Marett stated: "Bravo to Correas for solving the motor force mystery, and shame on them for not giving

Reich credit to Reich whom the credit was due.” We just want to emphatically agree with Marett. However, the PAGD device should stand or fall on its own merit, not on Reich's or the Correas' or Marett's reputation.

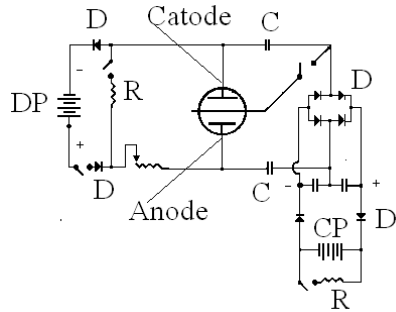
Correa's objective, as could be inferred from his patents [87], was to create an effective gas-discharge direct-alternated current energy amplifier to use in electric motorcars together with a common relaxation generator on the basis of a neon lamp (see Fig. 3.5.3). It was assumed that the electric motor operation had to be effected by changing the power voltage frequency, which from the energy viewpoint was more effective than the rheostat control (handling) of the direct current engine. In the course of the research it was discovered, according to Correa that the relation of the output electric power to the input amount exceeded 10 times (see Fig. 3.5.4).

The apparatus represents a common two-cathode gas-discharge vacuum device, which is wired according to the diagram (see Fig. 3.5.5). In its original form the Correa reactor has three electrodes, two of which are absolutely identical and works in a two-cycle regime (see Fig. 3.5.5). On the figure below a two electrode one-cycle system is considered. The original design is the following (see Fig. 3.5.6). The two-accumulator system seems a bit awkward. One of the accumulators maintains the anomalous gas discharge there and discharges, while at the same time the second one is charged, and then the accumulators exchange their places.

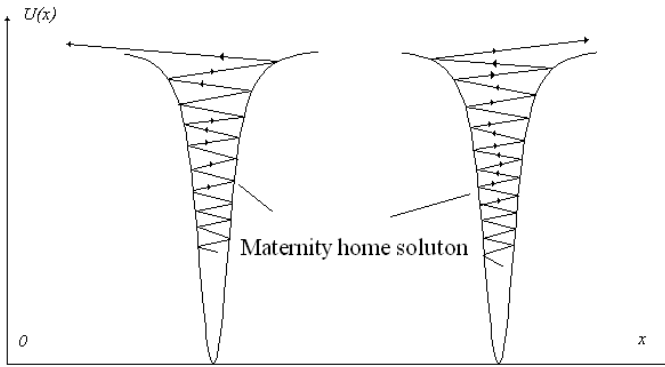
Why didn't Correa use a common capacitor with a big capacitance? It seems one might obviate the use of any kind of electric power source for the work of the device (the power might only be needed to start the device). In this case all the arguments of any opponent would fall away. When we addressed Correa this question we did not receive any answer. Anyway let us try to show in terms of the UQT that excess electric energy is, indeed, possible in such a system.



**Fig. 3.5.5** The Schemes of the installation with transformer.

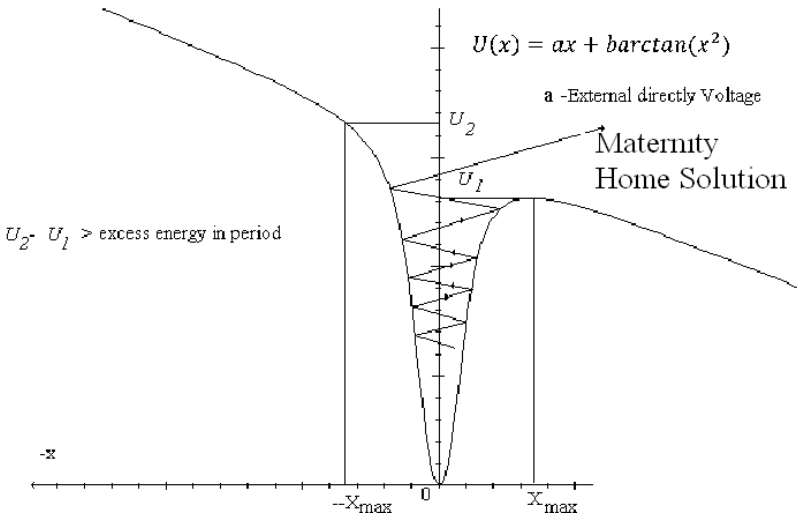


**Fig. 3.5.6** The Schemes of the installation without transformer.



**Fig. 3.5.7** The Maternity home solution is realized in a symmetrically parabolic potential wells.

From the physic-mathematical viewpoint it is clear that if the “Maternity” home solution is realized in a symmetrically parabolic potential well with identical walls [88], then there will be no excess electric current, as half of the electrons, having acquired energy, will flow to the left while the second half will be directed to the right (see Fig. 3.5.7) and these currents compensate each other. But if we take the well walls to be asymmetric, all the electrons subject to the



**Fig. 3.5.8** The Maternity home solution is realized in scewnes parabolic potential wells.

“Maternity Home” solution will flow to the left and contribute to the quickly alternating excess electric current component. The evident inequality should be fulfilled (Fig. 3.5.8):

$$W \ll U_1 - U_2, \tag{3.5.1}$$

where \$W\$ is the energy obtained by the electrons in the “Maternity home” solution within one period of oscillations.

We shall show that in a gas discharge plasma the situation described in Fig. 3.5.9 is possible. Let us consider the uniform plasma layer with thickness \$l\$ and transfer all the electrons to a distance \$x\$ distance. We will arrive at a plane capacitor (see Fig. 3.5.9) with an electric field between the plates

$$E = \frac{\sigma}{4\pi\epsilon\epsilon_0}$$

where \$\sigma\$ is the charge surface density

$$\sigma = en_x$$

Then

$$E = \frac{en_x}{4\pi\epsilon\epsilon_0}$$

This uniform electric field affects both electron and ion, but the latter will be at rest because of their big mass, so their motion can be neglected.

The force acting upon the area unit in a layer of  $l$  thickness is equal to the product of the layer's charge  $Q$  value by the field voltage

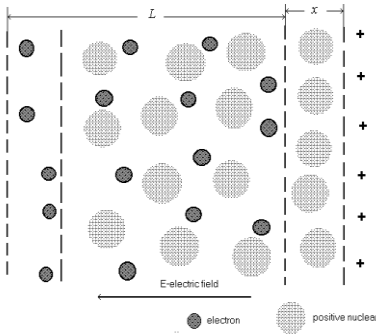


Fig. 3.5.9 The plasma oscillations.

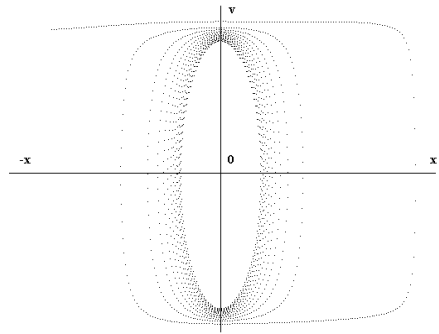


Fig. 3.5.10 The phase portrait of the oscillations with growing of the energy.

$$F = -QE = -en_x lE = -\frac{e^2 n_x^2 l x}{4\pi\epsilon\epsilon_0} = -kx$$

This force acts upon the  $M$  mass of all electrons available on the area unit

$$M \frac{d^2 x}{dt^2} = -kx$$

where  $M = n_x m_x l$

$$\omega = \sqrt{\frac{k}{M}}$$

As then

$$\omega_p = \frac{4\pi\epsilon_0 n_- e^2}{m_-}$$

The obtained frequency of plasma or I. Langmuir oscillations is usually within the limits  $10^9 - 10^{13}$ . Such plasma oscillations differ from the wave process, as they do not spread out in environment; in other words, some local disturbance remains local in character. The obtained differential equation for the plasma oscillations coincides with the conventional harmonic oscillator equation.

It is clear, that in collective movement of electrons each of them is also subject to this equation and due to this we can now use the main oscillating charge equation. It is evident from simple physical reasoning that if the current flows it means that the potential well has a wall. Although the well is symmetric by nature, it will become distorted in a strong electric field; its form will be similar to that shown in Fig. 3.5.8. Such a potential can be easily simulated by a simple function:

$$U(x) = ax + b \arctan(x^2)$$

Then the main equation that describes processes taking place inside the Correa reactor will take the following form:

$$m \frac{d^2 x(t)}{dt^2} = \left( a + 2b \frac{x(t)}{1+x(t)^4} \right) \cos^2 \left( \left( \frac{dx(t)}{dt} \right)^2 \frac{mt}{2\hbar} - x(t) \frac{dx(t)}{dt} \frac{m}{\hbar} + \phi_0 \right) \quad (3.5.2)$$

We have carried out below (see sect. 3.13) the numerical integration of equation (3.13.3) being similar to equation (3.5.2) and describing a similar physical process. The results show that there is a certain region of initial values in



which all the electrons, accelerated by the “Maternity” home solution will flow in one direction.

These very fast electrons are responsible for the anomalous excess heat on the anode (discovered by Chernetskij and Correa); it is the current spikes at the top of the pulses that contribute to the excess useful electric current component.

It is possible to make the following important statements concerning the Correa plasma reactor:

1. The cathode processes have nothing to do with excess heat, therefore of the [143]-type research is useless.
2. Inequality (1) is possible at large currents, which are easier to obtain in a pulse regime.
3. The plasma composition is not very essential, ionization potential serving as a single criterion of importance, but it is desirable to choose it to be as small as possible.
4. At large currents the cathode electrode dispersion is inevitable. It leads to the metal erosion and its settling down on the flask (retort) walls, which shortens the device life. Correa had used Aluminum for the electrodes and this was not a very successful decision. The use of liquid metals (for instance, Hg - mercury with a sufficiently small output work) for the electrodes seems to be more expedient. Having been condensed on the walls it would trickle down to the liquid electrodes. Such electrodes would have a very long service time. It is natural that further recommendations could be made after preliminary experiments.

In conclusion of this section it is impossible to say nothing about the problem

of the negative resistance origin in gas discharge. If the heat is generated at current flow through active positive resistance, the negative resistance is exactly an energy source. It is necessary for that to join in parallel general oscillatory circuit to such a negative resistance. Continuous waves will spontaneously appear within the circuit.

At the earliest stages of radio electronics the first radio transmitting equipment was based on that principle. Most likely the area of negative resistance of voltage-current characteristic coincides with the area the processes of particles acceleration in asymmetrical potential well (like Fig. 3.5.8) are most effective (“Maternity Home” solution).

However no serious books (or works) dealing with the theory of gas discharge contain a clear physical explanation of the negative resistance appearance when the voltage is decreasing and the current increasing. Now it is evident that particles acceleration in potential wells like one in Fig. 3.5.8 is responsible for that process.

### **3.6 Possible Application of the Unitary Quantum Theory in Microelectronics**

*In the world literature it is written that tunnel diode has been constructed by Japanese researcher Esaki. However, at the end of forties in Soviet popular magazine “Radio” was published a series of articles about “crystadin” created by Russian ham Oleg Losev. He used a falling sector of voltage-current characteristic of point contact between steel wire and homemade crystal FeS. Such diode was made from mixture of iron filings and sulfur powder heated within test-tube. The obtained coked mass was then broken into pieces from which suitable crystal was chosen. That prototype of tunnel diode was used for oscillatory tuned-circuit*

*Q-factor excursion in general crystal set. Articles described the way to do it at home. One of the authors did himself being a schoolboy.*

The unitary quantum theory predicts a number of new phenomena that occur when charged particles pass through a potential barrier. A new type of semiconductor devices can be created based on [104, 106]. The oscillating charged particle equation that was suggested in [172, 200, 201] to explain the cold fusion should be used to analyze these processes.

The above equation determines relationship between the particle passing through the potential barrier and the wave function phase. In other words, if the charge of a particle that approaches the barrier is small, then it passes the barrier quite easily. Due to this small-energy deuterons can approach each other and interact but this effect takes place only within a narrow phase range.

In order to describe the particle's behavior while passing through a periodic sequence (chain) of potential barriers we shall use the simplest potential of the kind:

$$U(x) = Ex + A \sin^2(x)$$

Then the equation for the particle's motion within such a potential with a superposition of a weak uniform field (external operational field) will assume the following form:

$$\frac{d^2x(t)}{dt^2} = (E + A \sin(2x(t))) \cos^2 \left( \frac{t}{2} \left( \frac{dx(t)}{dt} \right)^2 - x(t) \frac{dx(t)}{dt} + \phi_0 \right),$$

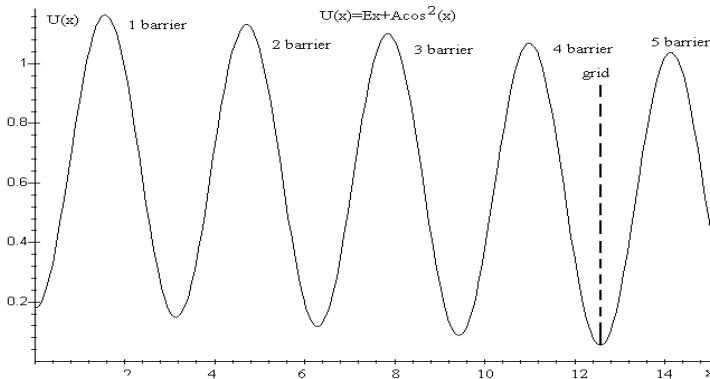
where E is the small external operational voltage (power supply).

Assume that a certain number of charged particles with a uniform phase and Maxwell velocity distribution move through a periodic chain of potential barriers

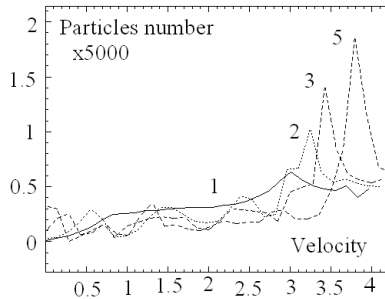
being subjected to action of external electric field. According to the UQT nearly all the particles which have passed through the barriers have approximately equal velocities and phases (a coherent flow). It is interesting that the slow particles are accelerated while the fast ones are slightly slowed down. Consequently, the particle's phase changes too. To check this point the following problem was set: upon a sequence of five barriers (Fig. 3.6.1) a flow of particles is directed, the particles possessing various velocities (uniform distribution with respect to velocities) and various initial phases uniform distributed in the  $0 \dots \pi$  region.

In practice this problem was solved with a mathematical program in two cycles. The first velocity-cycle contained a phase cycle (101 phase-values were used) in the  $0 \dots \pi$  range. The number of phase values should always be odd, as in even splitting the point  $\frac{\pi}{2}$  was sure to emerge and the PC would hover for many hours until it reached zero due to the equation's singularity in this point. The velocity range was split into 500 intervals (stretches). Thus, the particle's motion equation was solved by the Runge-Kutt method of the fourth order  $500 \cdot 101 = 50500$  times, the procedure taking no less than a month with ordinary PC.

In fact, the standard Monte-Carlo procedure was applied within the two cycles. If the particle changed its velocity sign (was reflected), its behavior was not considered anymore and it was excluded from the analysis. All the trajectories are calculated, the histograms of the particles number distribution in relation to their velocity are made, these results are given on a plot (see Fig. 3.6.2).



**Fig. 3.6.1** The Potential Barriers.



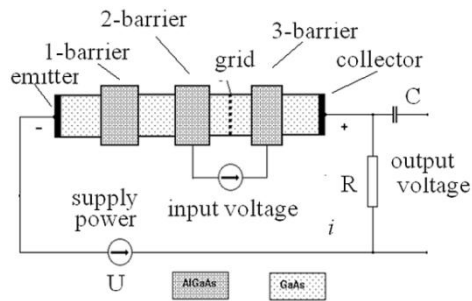
**Fig. 3.6.2** Dependency of the number of the past particles depending on velocities and numbers barrier.

As seen from the plot (Fig. 3.6.2) a lot of particles possess identical velocities and phases having passed through 5 barriers. It is clear that such automatic phase and velocity phasing in a periodic potential sharply raises the probability for the deuterons to approach each other, which in itself serves as an additional argument to CNF explanation [53]. Of course, in real lattice this effect is much weaker, because the solved problem is one-dimensional. In order to solve a three-dimensional lattice model (pattern) one needs a lot of time and a very powerful supercomputer.

But the experiments on the tunnel-effect dependence upon the wave function phase should be carried out by all means. Such a problem has never been considered in quantum mechanics because the wave function square module rather

than the wave function itself has the physical meaning and hence the wave function phase has been excluded from the analysis. If the relationship between the particle passage through a potential barrier and the wave function phase will be proved experimentally it will serve as a crucial evidence of the UQT validity and will allow creating electronic devices based on new electron-control principle.

Let us regard the operational principle of such a new device, its schematic diagram being given in Fig. 3.6.3.



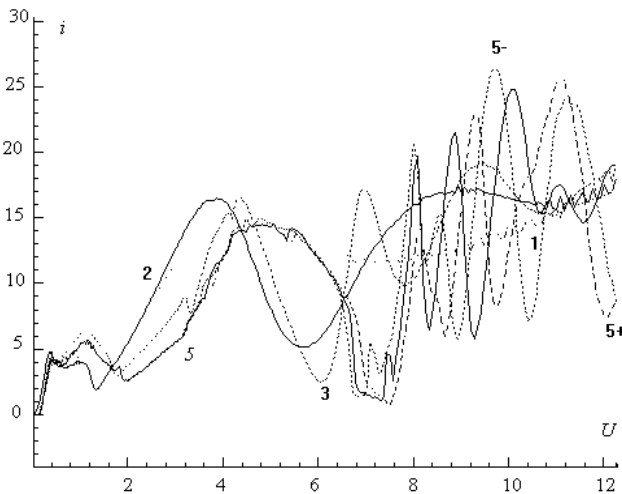
**Fig. 3.6.3** Scheme of the new transistor.

This semiconductor includes several equidistant potential barriers produced by introducing impurities and a grid structure between the 2-nd and the 3-rd barriers. The processes that will take place within such a device can be easily predicted: all the electrons with equal phases but different energies will pass through the 1-st barrier. The electrons with de Broglie wave length, equal to distance between the two barriers divided by  $N$  (where  $N$  is an integer number), will also pass the 2-nd barrier. The energy deviation being rather small, a monoenergetic equal-phase (coherent) electron flow will be formed upon passing through the second barrier. Consequently, any change of a grid potential between the 2-nd and the 3-rd barriers will cause the electron phase change at approaching the 3-rd barrier and hence the amount of electrons having passed through the third barrier will decrease.

The above-predicted results were simulated on the same 5-barrier chain, the

grid being placed between the 4-th and the 5-th barriers, which did not bring any essential changes of the situation. The resulting current behind each barrier had been summed up. In the current value calculation each particle's velocity and instant charge were taken into consideration.

In fact, for a 1-, 2-, 3-, and 5-barrier tunnel diode mathematical simulation was carried out. The dependence of each behind-barrier current upon the squared velocity of incident particles (this value being proportional to the device operational voltage) is shown on the plots in (Fig. 3.6.4).



**Fig. 3.6.4** *The Electric current after passing several barriers.*

It is clearly seen, that within the resulting 5-10 range volt-ampere properties there is a place with a negative resistance, and on the whole these characteristics give a sufficiently accurate description of the tunnel diodes (Fig. 3.6.4).

Further on, mathematical simulation of a new kind of device has been made, the concept of the latter is presented in Fig. 3.6.3 and its operational principle is described above. To achieve this velocity of each electron that passed through the 4-th barrier was changed by 5% as compared with its calculated value; the

charge's instant character had been taken into account. In other words, an attempt was made to imitate the grid, which either accelerated or slowed down by 5% the electrons that had passed the 4-th barrier; the current that had got through the 5-th barrier was also calculated.

The results are given on a summary plot (Fig. 3.6.4), where two more curves representing positive and negative grid voltage, correspondingly, are shown. The simulation's outcome had surpassed our most far-reaching expectations; although it looks much more complicated than was expected proceeding from the above theoretical reasoning. The simulation analysis shows that there are some voltage areas, where the gain coefficient is very high; therefore, doubtless, devising of such instruments holds very much promise.

Some strange things are also observable: the current through the 2-nd, 3-rd and 5-th barriers may at certain voltage values be bigger than through the 1-st barrier. Any researcher can ask a legitimate question: how can it be possible within a series resistor circuit with one and the same current flowing? The answer to this strange paradox is rather simple: the phases of all electrons passing through the chosen point are such that their summed up charge varies only slightly, which leads to various current values at different points. Note, that just the same phenomenon is arranged by Nature within the so-called "Lecher wires (patterns)".

It is experimentally established that within the Lecher wires (lines) there are some points in which the voltage is equal to zero. The lines can be short circuited in these points without any change in voltage on a payload at the line's end. Similarly, there are points, where the currents run through the wire are equal to zero and the wire can be safely cut in these points without any damage done.

Besides, the plot (Fig. 3.6.4) reveals another curious phenomenon: one can see that all curves have common intersecting points at voltage values of 1.6 and 6.4.



This is a consequence of a trivial resonance effect, when de Broglie wave length changes by 2 times. In so doing, as the phase had altered by  $2\pi$ , nothing will change in the probability for the electron to pass through the barriers via these points.

In electronics there are two principal ways to control the electron flow only:

1. Control by interception, when a common vacuum electronic triode or a lock (closing device) (a field or channel transistor) the amplified signal exercises control with the help of a grid (netting) over the number of the electrons passed, while the controlling element represents something like a bar (gate, valve) within the water flow.
2. This way of control involves the procedure in which electrons are slightly accelerated or slowed down with the help of the amplified signal, which leads the velocity being modulated. Then in the course of their movement in free space the faster electrons overtake the slow ones and the flow splitting or grouping into space charge clots occurs. Further on this density modulated bunch of signals interacts with the resonator or with the system with slow wave. Such a method of control is used in all the super-high-frequency devices - magnetrons, amplitrons, klystrons, TWT, canceratrons etc.

Note, that the proposed (suggested) way of controlling the electron flow is, in fact, essentially new and unknown to science because the tunnel effect dependence upon the wave function phase has not yet been established. It is clear that it is easier to control the electron wave function phase than to use other control procedures.

There is no need to wait for a long time till the velocity modulated signal bunch will group into clots in the free space. Therefore such a device could apparently

allow obtaining very prompt work. Probably, it would be expedient to develop this new semiconductor device on the basis of either Ga-As or Al-x-Ga-x-As super lattice devices, proposed by Esaki L., Tsu R.[105], Japan. It could also be achieved on the basis of common tunnel diodes [107] or a resonance-tunnel dipole transistor [108, 109].

This experiment could be carried out in institutions possessing sub-micron semiconductor technology. It is also necessary to make a super pure semiconductor device with the electron free path length being greater than the device's dimensions. So, the electron flow control devices seem to be quite possible and new electronic devices using the phase control mechanism can be made. The consequences of these developments are to be very far-reaching.

### **3.7 Anti-Stokes Luminescence**

*What shall you say for this, the Physics? Friction among people leads to coolness in their relations.*

*“Shaggy thoughts”. Stanislav Yezzy Lets.*

It was discovered early in the last century that some luminescent solids (substances which glow after an exposure to radiation or seem to accumulate the light energy) manifest a strange feature: they give out light with a wavelength shorter than that of an incident (exciting) light flux. This effect was given the official name of anti-Stokes luminescence [110-112, 116]. In other words, it is the ability to transform, convert, or turn not only the exciting light into heat but also the inner (heat) energy of the substance into the light. It is, in fact, an ability to accumulate heat. For many decades there was a narrow academic argument going on whether in the course of over-irradiation the light could carry away some of

the luminescent solid's energy. This resulted in an admission of the possibility of efficiency more 100% under a number of strict conditions.

The thermodynamic validation of this fact was achieved at a very high cost. The time component had to be introduced into equations - that was impossible (prohibited by the canons) in terms of the thermodynamics postulates. This fact acquired a practical value starting 1961 when S. Jatsiv [111], Japanese, proposed to use luminescence of a gadolinium compound for the optical cooling. Numerous measurements have shown in indirect way that the luminescent solid cools down, i.e. it emits more light energy than it has received [110, 112]. In 1966 there was report (A. T Aronov, B. M. Vool and others) on the electro-luminescence energy output up to 1.1, attention being paid to the fact that the sample's cooling was compensated by taking the heat from the environment. The established efficiency could achieve 1.6, the crystal being cooled up to 26.6 C, the irradiation amounting to 1 Watt/cm<sup>2</sup>.

Moreover, it is widely known that fuel elements installed on board the American "Apollo" and "Gemini" spacecraft also have an efficiency of more than 1(?!).

### **3.7.1 The Electric Conductivity of Water**

Another mysterious phenomenon is associated with the electric conductivity of water: in numerous experiments of various researchers an anomalously high electric conductivity of very pure water (with the concentration of which corresponds to H<sub>3</sub>O and OH equal to 10<sup>-7</sup> – 10<sup>-8</sup> has been established. As the energy necessary for the molecules dissociation should amount to about 3 eV, it is easy to evaluate with the help of Gibbs statistic multiplier (factor) the resulting concentration of dissociated molecules:

$$n = A \exp\left(-\frac{\Delta E}{kT}\right) = A \exp\left(-\frac{3}{0.025}\right) = A * 10^{-52},$$

where A is the coefficient of entropy having the order of several units. It is easy to yield to temptation and declare that such high dissociation is caused by energy generation processes that occurred in free spaces among the water clusters (pseudonuclei).

### 3.7.2 The “Levy Flight” in Brownian Movement

One more absolutely unordinary occurrence is the so-called “Levy flight” in Brownian movement. It was discovered by a team of French researchers [113] that in certain specific systems intended for study of Brownian movement some particles, being subject to random impacts of their neighbors, travel very far and it is absolutely unclear where they take the enormous energy needed to achieve this. Here we observe violation of one of the most important laws of mathematic statistics - Lyapunov’s Central Limit Theorem. That is why the authors of the experiment are faced with problems of theoretical interpretation. From the UQT viewpoint this is a natural result because here some energy generation process is going on. Curious but the process of similar origin is responsible for energy generation in Correa’s plasma reactor [87].

### 3.7.3 The Experimental Results of Professor Kasagi Group

It is possible to explain experimental results of Professor Kasagi group [114] on the basis of the conventional classic electrodynamics invoking the UQT idea about varying electric charge of a particle and its movement in space: when passing through a barrier field of intensity E

$$\mathbf{E} = -\text{GRAD } U(\mathbf{r})$$

the particle acquires acceleration

$$\mathbf{a} = -\frac{e\mathbf{E}}{m} = -\frac{e}{m} \text{GRAD } U(\mathbf{r}),$$

the energy  $dW$  irradiated by the particle within the time  $dt$  is proportional to a square of acceleration  $\mathbf{a}^2$  and is equal to

$$dW = -\frac{2}{3} \frac{e^2}{c^3} \left( \frac{e}{m} \text{GRAD } U(\mathbf{r}) \right)^2.$$

It is seen that the irradiated energy (which is directly associated with the “bremsstrahlung” probability) is proportional to the fourth degree of charge -  $e^4$ .

When the particle passes the barrier its charge decreases until the particle leaves it the charge grows. If the charge is very small, then the probability of radiation will be small too, but Professor J. Kasagi has another explanation, which, also, seems to be correct. The choice between these viewpoints is difficult. Moreover, another element of uncertainty is connected with unclear processes of strong interactions. Therefore it's not correct to stage similar experiments to prove the trigger point, although it can confirm UQT assumptions. In case we use some installations to determine the tunnel effect probability dependence upon the wave function phase, there will be no need in any alternative explanations (they will have a very general character).

We would like to recollect that within conventional quantum theory the probability of passage is not generally dependent upon the phase and to-day it will be difficult for us to explain any negative result. The negative result will mean that the UQT is not a true theory. Whereas a positive result will not prove the UQT validity, because it is impossible to prove any theory's validity, as there is always an opportunity that some of the results may turn out to be negative.

Therefore, the experiments on verification of tunnel effect probability dependence upon the phase should be considered a trigger point of all the research. Our principle interest at present is the resulting possibility to create new electronic devices. In fact, staging of such an experiment will be much cheaper than more sophisticated experiments on nuclear installations. It could be made on the basis of Motorola, Hitachi, Sony or NEC or some other firm interested in production of tunnel diodes and chips.

There is a strong impression that theoretical physics, although considered a respectable science, is not being paid much attention to a number of serious research institutions (such as NASA, Motorola, etc.) when dealing with fundamental problems and that seems to be quite correct.

These simple and clear results alongside with others (for instance, the Gibbs paradox) compel us to scrutinize over and over again the thermodynamics statistic foundation and the impact of the UQT on its postulates.

### **3.7.4 Tunnel Effects in Proximity to Zero Point Temperature (Single Electronics)**

Recently in the United States a number of surprising experiments were carried out. First, they may be considered as the direct confirmation of the electric charge oscillations. Second, the standard quantum mechanics in this case altogether unacceptable, therefore the explanation offered by the authors [57], seems superficial and erratic. In fact, these experiments serve nowadays as the first direct evidence of the Unitary Quantum Theory validity and prove certain inadequacy of the Quantum Mechanics classic Copenhagen interpretation.

Let us consider these phenomena more detail. We shall start with a simple question: which is the smallest charge to occur on a “pinhead”? From the UQT

viewpoint the answer is very simple: if there is only one electron on the “pinhead”, then the smallest charge value may range from 0 to  $-2e$  (the charge averaging takes place in conditions of frequent oscillations and we observe the  $e$  value), i.e. for any value within the said range, but taken separately, the charge value at a certain time point will be dependent upon the phase, the correlation, naturally, being different in different systems of measurement.

In terms of rigorous quantum mechanics the answer is much simpler: the “pinhead” consists of electrons, protons and neutrons. Each individual proton or electron possesses either  $+e$  or  $-e$  charge, whereas the neutron has no charge. The total (summed up) “pinhead” charge will be equal to the number of electrons minus that of the protons. From this inevitably it follows that the smallest charge value should be  $+e$  or  $-e$ .

Yet, recent experimental results [115] show that the above is not true. They evidently point to the fact that the “pinhead” charge may be equal to a part of the electron’s charge, for instance, to a half ( $0.5e$ ) or one tenth part of it ( $0.1e$ ). The said experiments involved extremely small structures (samples) of the order of 300 Angstroms, which represented a common tunneling transition. Such tunneling device consists of two conducting electrodes (made of aluminum) separated by a thin dielectric layer (aluminum oxide) with a 10 Å thickness. If voltage is applied to such a tunneling device, the electrons will start tunneling through the dielectric basically in one direction. As a result of this, due to the electrons movement through the tunneling, a certain current flow will be observed.

Direct experiments with devices of this kind have yielded a surprising result: if a direct electric current flows through the transition (tunneling), a periodically varying voltage will be built up on the electrodes with a frequency being equal to the current value versus electron charge ratio. This phenomenon is called “set oscillations”. It is clearly seen that the same effects take place in the course of

analysis of the new electron device theory, as the current is different in different points, which means different charge values at different points and serves as a prerequisite of the potentials' periodical difference.

The electric current flows through the conductor due to the fact that some electrons are free and may move freely within the lattice made of atomic nuclei. Irrespective of the electrons movement the conductor of any given volume (size), in fact, has no charge, as the negative charge of the moving electrons is always compensated by the positive charge of the atomic nuclei within any given conductor volume. Consequently, it is not the total (summed up) charge within any given volume, which serves as important quantitative characteristics, but the value of the charge carried (transported) through the conductor.

The most surprising in the experiment is the fact that the transported charge can have any value, even fractions of the electron charge. Further on, the authors of the work [115] give a superficial, or to be more exact, not quite correct explanation of the observed phenomenon. The authors' physical concept of the occurring process is following. The transported charge value has very little to do with the summary count of the protons or electrons number. This charge is proportional to the summed movement of all the electrons in relation to the atomic lattice. As the electrons inside a conductor can be shifted for an infinitely short or long distance this sum can vary gradually and consequently the same can be said about the carried charge value.

If necessary, the charge carried through the conductor may be changed incessantly (continuously) within the range from zero to  $+e$  or  $-e$ . If the common conductor structure is interrupted by a tunnel transition, then the electric current flow within such a system will be both of uninterrupted or discrete character. When the carried charge is moving within the conductor continuously it will be accumulated on the electrode surface at the tunneling insulation layer, the



opposite electrode having charge equal by value, but opposite in sign. This surface  $Q$  charge may be represented as a gradual insignificant electrons shift near the surface in relation to their position in a state of equilibrium.

The authors of [115] observed that phenomenon at tunnel transitions being very small and the surrounding temperature being extremely low (in liquid helium conditions). Low temperatures are necessary to reduce heat oscillations (fluctuations), which bring chaos into the movement of electrons. In this case if the  $Q$  charge at tunneling is bigger than  $e/2$ , then the electron is capable of passing through the barrier in definite direction reducing the value of  $Q$  by  $e$ .

The possibility of tunneling is explained by the fact that this process lowers the system's electrostatic energy. Similarly, if  $Q$  is less than  $-e/2$  the electron may start tunneling in the opposite direction, increasing the charge  $Q$  by  $e$ , then the system's energy is again reduced as a result of this. Yet, if the  $Q$  charge is less than  $+e/2$  and bigger than  $-e/2$ , then tunneling in any direction will increase (!) the energy of system (it is absolutely unnatural from the physical viewpoint – our remark). Consequently, if the initial charge value is within the given range, tunneling will not take place. Such tunneling suppression is called the Coulomb's blockade.

The authors of [115] suppose following. Let a single electron to approach the barrier (if the electrons are numerous then their further assessment will look even worse for the authors of [115]-our remark) having the charge  $e$  (or  $-e$ ). The passing through the barrier is possible if the electron's charge will change in proximity of the barrier's border-line by value not less than  $e/2$ . Meanwhile, such charge's changing may proceed provided by the moving electron displacement to the distance of electron's radius order. Such displacements are easily controlled by the fixation of the moments when the Coulomb's blockade begins and ceases.

In other words, the experiments show the possibility to determine indirectly the

electron's co-ordinate with accuracy equal to half its diameter!!! This is obviously true only within the classic mechanics, but utterly impossible in terms of standard quantum mechanics because of the following reason: it is a well known fact that the exact ordinate and momentum values of an electron cannot be measured simultaneously, although each value taken separately can be measured to any degree of accuracy. The exactness of the electron  $\Delta x$  co-ordinate determination is related to the  $\Delta p$  momentum measurement accuracy through the Heisenberg correlation:

$$\Delta x \Delta p \geq \hbar$$

If the co-ordinate's accuracy measurement is equal to  $\Delta x = 10^{-15}$  cm, then it is possible only at energies of the GeV order, but the electron energy confined within the lattice at helium temperatures is billions of times less and the only possible explanation to-day is the charge oscillations of the moving electron.

But the other circumstance is the main. The fact is that electrical current flow is stopped during Coulomb's blockade and electrons become motionless and their impulses become exactly known (are equal zero). The coordinate of given electron becomes quite indeterminate in this case and we don't know even what electron is observed (!). Just the idea of charge oscillations supposed by our theory allows to give the only correct to-day explanation of observed phenomena.

And this means that the UQT is valid in this case whereas the standard quantum theory fails.

It should be noted that quantum mechanics in general is not concerned with single events (in which only one particle participates) and had never claimed to do so. Final elucidation of this circumstance took place under the impact of A. Einstein and E. Schroedinger works.

On the other hand, it is important to remark that the oscillating charge equation always remains a single particle equation, which is absolutely uncharacteristic of standard quantum mechanics. This fact should be viewed both as fundamental and extremely important.

### 3.8 “Nuclear Democracy” and Anomalous Slow Processes

*Occasionally I'm able to do without something necessary, but never without luxuries*

*A. P. Chekhov*

Intermediate or composite nucleus – in some nuclear reaction at compound nucleus – is an intermediate, relatively long-lived composite system consisting of nucleus and a trapped flying particle. Its decay to radioactive products somewhat depends on the mechanism of its composition.

That model was introduced by N. Bohr as far back as 1936. According to it a nuclear reaction is proceeded in two stages. At first fast stage the flying particle is penetrating into the nucleus and gets captured. Due to the strong interaction the excitation energy is rapidly distributed among all the nucleons of the nucleus. It seems that the particle becomes entangled in the core of the target so the average extraction energy appears to be less than cohesive energy (approximately 8 MeV). During a long time it is unable to leave the nucleus until all nucleons located near the nucleus band have again collected the energy exceeding the cohesive energy. But what shall we do with the Carnot theorem?

The other possible way of composite system decay is the emanation of  $\gamma$ -quantum. It is well known that it is quite a slow process too. Life interval of

such composite system is extremely long; sometimes it is million times longer than the estimated time of the particle's flight through the nucleus-target. After the expiration of so a long time  $\tau$  (the system seems "to forget" the way of its creation) the second stage of nuclear reaction begins. It is the intermediate nucleus decay, following either in the flying of a similar particle either another nucleon or a  $\gamma$ -quantum (in general by other processes too).

The probability of the intermediate nucleus decay is

$$\omega = \frac{1}{\tau} = \frac{\Gamma}{\hbar}$$

where  $\Gamma$  is the width. The nucleus may split by different channels. So the probability of the decay can be presented as a sum of partial probabilities along different channels, each of them characterizes one separate way of decay:

$$\omega = \omega_\gamma + \omega_n + \omega_p + \omega_\alpha + \dots = \frac{\Gamma_\gamma}{\hbar} + \frac{\Gamma_n}{\hbar} + \frac{\Gamma_p}{\hbar} + \frac{\Gamma_\alpha}{\hbar} + \dots$$

The relative probability for the composite nucleus to decay through definite channel is equal to

$$\eta_i = \frac{\omega_i}{\omega} = \frac{\Gamma_i}{\Gamma}.$$

Of course, the existence of an intermediate or composite nucleus is possible, but one can be confused by the circumstance that the energy of the flying particles may be a portion of eV and the energy of the flying out (born) particles is sometimes the same. It is well known that the first levels of the excited nucleus usually lie above the general one approximately at 400 KeV. Here utterly strange levels with the energy of bits of eV suddenly appear. Besides they are extremely narrow. But even more queer is that the extremely small energy of the flying out

particle (according to existing quantum theory) always first of all “spreads” over all nucleons and then, in a complete contradiction with the Carnot theorem, again gathers together in one particle. Later that particle is able to flight out. It is incomprehensible how it has managed to overcome the forces of nuclear attraction between nucleons (the energy of such strong interaction may be near 8 MeV). These processes can be detected for both protons and neutrons.

All these circumstances have resulted in the appearance of sarcastic remarks in some theorists about “nuclear democracy”: after a particle with small energy has flown into the core of the target (nucleus) “the latter is worrying for a long time because of the discussions in nuclear parliament about what nucleon and when should leave the nucleus and if there is not enough means (energy), they are assigned anyway”. And all these debates need time. Here in Russia we say that any joke contains a bit of truth. We are not going to criticize that perfect bureaucratic analogy, but its existence points for us.

N. Bohr had even invented special drop nucleus model working in few cases only (for example it could not explain the existence of magic nucleus at all). In general we can say that till now there is no good model of the nucleus because strong interactions are as complicated as possible and till now there is no in the slightest degree suitable universal mathematical expression for strong interactions potential.

It seems to us that all troubles with the abnormal long time of particle (proton) flight through the nucleus-target are generated by “snail effect” (section 3.1). The same effect is responsible for all other abnormal slow processes. The delayed neutrons able to leave the nucleus after few minutes can be also “explained” from this point. It is only due to that phenomenon we are able to affect nuclear reactions at thermal neutrons in reactors.

Note the behavior of neutrons and protons are different. Evidently the proton flying towards the nucleus spends a lot of time for overcoming Coulomb repulsion (snail effect). But when it leaves the nucleus it does it quickly thanks to helpful Coulomb interaction. For a thermal neutron the Coulomb interaction nearly does not exist (the interaction due to the magnetic momentum is sufficiently small in comparison with the Coulomb interaction for protons). In quite short time the neutron reaches the nucleus, but when it (or other neutron) is leaving the nucleus the snail effect appears again while overcoming the forces of nucleus attraction.

Of course for that it should be assumed that oscillating mechanism of charge is universal, i.e. suitable for not only electromagnetic coupling but for strong interaction too. From the viewpoint of the UQT all reasons are voting for it because vanishing in some points wave packet in the UQT, and so in these points all interactions disappear.

In accordance with general nuclear physics delayed neutrons (approximately they constitute 1% of total numbers) may appear only when the nucleus is exited with the energy higher than the cohesive energy of one neutron in the nucleus. As usual the mechanism of delayed neutrons emission is related with the  $\beta$  - decay of such nucleus, but it must be over-laden with neutrons. Of course that process also takes place and makes its contribution to delayed neutrons.

### **3.9 Photoluminescence of High Porosity Silicon**

*Most great truths were blasphemies at the beginning.*

*Bernard Shaw*

The experiments described below were as if specially performed for the check

of the Unitary Quantum Theory and its basic prediction - energy generation. In 1956 A. Uhler [117] was the first to obtain porous silicon by means of special electrolytic etching in hydrofluoric acid. This substance was a monocrystal of very pure silicon with an enormous quantity of microscopic pores, which was formed in the result of etching. The porous density was so great that the porosity coefficient (the relation of the removed material to the initial quantity) reached 50-85%. Such silicon was characterized by numerous interfaces and possessed tremendous internal surface area of up-to 600 m<sup>2</sup> per 1 cm<sup>3</sup>. The electronic microscopy revealed a great number of caverns measuring 10-100 Angstroms, connected with each other by minuscule passages. In fact, the said material had a coral-like structure.

But a real sensation in microelectronics was in 1990 when L. Canham and his team of researchers [118] accidentally discovered that when electric current was applied to the porous silicon a sufficiently strong red-orange photoluminescence at room temperature appeared. Practically at the same time similar phenomenon was discovered in France [119]. It was a challenge to theoreticians and experts working in the field of semiconductor physics. Yet, there is still no satisfactory explanation of the observed processes. Only few believe that the effect is based on the electrons recombination and holes [120], besides this explanation stands in direct contradiction to some experimental facts. In terms of the Unitary Quantum Theory porous silicon differs very little from the water cavitations bubbles in Yu. Potapov [60-62] and J. Griggs [68-69] heat installations.

When a weak electric current passes through porous silicon, a free proton gets into a cavity and starts generating energy at certain initial conditions. This process is described by the “Maternity Home” solution. The «bremsstrahlung» irradiation of the energy-saturated proton causes a red-orange photoluminescence. The potential well destruction by energy-saturated protons would entail destabilization

of this effect. This fact was observed in different experiments. Moreover, if one fills the pores (caverns) with molecules of light organic compounds (ethanol, methanol, acetic acid) that cause a shift of the photoluminescence stripe from the red into a yellow-green area [122].

According to the UQT this effect can be expected when the mass of the particles oscillating within the well is increasing. There is another more surprising experimental fact [120-122]: heating the newly prepared porous silicon to temperatures exceeding 250 degrees Centigrade results in total disappearance of the luminescence.

Careful analysis showed that at such temperatures the hydrogen left silicon just after the pores forming in acid electrolyte disappears from the sample. At present there is an impression that these experiments serve as direct confirmation of the UQT, but the authors dream the other independent researchers could share this conclusion.

### **3.10 The Possible First and Second Thermodynamics Law Restriction**

*«...superposition of alive and dead cats states»*

*E. Schroedinger*

#### **3.10.1 The First Thermodynamics Law**

The most mysterious, of course, are phenomena associated with energy generation processes - excess energy in cavitations bubbles and caverns, CNF, catalytic reactions. The said phenomena were discussed in more details in our



earlier publications, therefore we are not going to focus on them in this book, but we shall try to analyze their impact on physical science. It is to be underlined that thermodynamics is an absolutely consistent science and there is no use to look for contradictions within it.

Our present discussion will be concerned with main postulates of thermodynamics and the restrictions in use of the First and Second Thermodynamics Laws which arise if UQT is valid. Note that the official science recognizes absolute truth of the First and Second Thermodynamics Laws in all the fields of life [123-125].

To overcome the contradiction it is more expedient to consider the First Thermodynamics Law as a convenient postulate extremely useful in describing a wide range of phenomena, than to apply it indiscriminately (without proper careful analysis) to all cases, being fully aware that rigorous mechanics doesn't work here. This problem was dealt with in details in Sapogin's report prepared for the International Conference "Nuclear Power Engineering in the Third Millennium" (Obninsk, Russia, October, 1996).

Further to abovementioned (section 3.2) the law of energy and momentum may be derived within Unitary Quantum Theory after averaging over all initial phases of numerous particles, but these laws are not valid for a single particle. Since Thermodynamics is in general a statistical science, its First Law is quit not bad postulate and will serve the Science for a long time. Nevertheless, some fields of Science and Techniques have appeared where this law is not inviolable.

### **3.10.2 The Second Law of Thermodynamics**

If the First Law of Thermodynamics is now unquestionable (let us remind you that starting from 1755 the French Academy of Sciences had established by fiat

the Law's universal application and up to now there has been no evidence that this fiat being wrong from the viewpoint of the classical physics), then the situation is different in respect to the Second Law of Thermodynamics. Here we can't help citing some pillars of thermodynamics and prominent physicists.

First, we wish to express our own viewpoint: through the mossy grating of the Second Law of Thermodynamics our future looks indeed dark and horrible: thermal death of the Universe and energy crisis. It should be noted that the process of the Universe thermal decay has been suspended and can hardly be envisaged within the nearest billions of years! As regards the energy crisis on the Earth this problem is sure to be solved within 5 or 6 years. Most probably there are systems in which the Second Law of Thermodynamics has a limited application. Fortunately, other researchers share our viewpoint.

Thus, I. Prigogine, the Nobel Prize Laureate and author of non-equilibrium thermodynamics, says: "... now, one hundred and fifty years later, after the Second Thermodynamics Law was formulated, it still represents a program rather than a well-defined theory" [140]. So far even the field of its validity or application hasn't been delineated. The two greatest Russian minds, K. Ciolkowski and prof. V. Vernadsky, always doubted the Second Law's absolute truth. K. Ciolkowski even wrote an extensive research work named — The Second Law of Thermodynamics in which he showed the latter's limitations [126].

But it was probably J. Maxwell who saw for the first time the necessity or, to be more exact, inevitability of certain restriction for the Second Thermodynamics Law. He wrote [127, 128]: "... our conclusions proceed from experiments with bodies, consisting of uncountable number of molecules, they may turn out to be wrong when applied to more subtle cases and experiments, which could probably be performed if one learnt to differentiate and control molecule".

J. Maxwell was the first who introduced statistic methods in gas laws and he had to work hard on a problem what entity should be considered as a sand-hill (heap)? Two, five ... a thousand grains of sand? In other words, starting from which number of molecules the statistic laws become really valid? The statistical analysis of molecular systems consisting of a huge number of molecules allows to obtain certain mean (statistical) values of various parameters describing the behavior of given systems on the whole. Their knowledge is usually sufficient in majority of practical cases. But average values differ from the exact for a single molecule or for a special group of molecules. It is assumed in conventional thermodynamics that when molecules collide its energy and momentum are strictly conserved within the elementary act (taken only for two particles [132, 133]). In UQT the same is not true for two particles, but remains valid for the particles' assembly when summed up at all their starting phases. However, it is still unclear what consequences does this discrepancy entail.

But practical benefits, a possibility to achieve quick results, have overshadowed development of a more direct, simple and, in fact, more potent dynamic procedure. And it was not accidental that Maxwell did not ascribe to his statistic method any other meaning than that of a temporary solution for the situation. It was likewise natural that he, seeing how different and sometimes even quite opposite are the results of both methods, had devised a special kind of "entity" known under the name of "Maxwell's demon". Over the past centuries the demon had made a useful contribution to thermodynamics. In particular, this demon did not allow the faith into the Second Thermodynamics Law to become unlimited, as was the case with the First Law. Maxwell wrote [127]:

*"... imagine a creature with a sense of perception so acute that it can trace any molecule trajectory; such a creature, with capabilities essentially as finite as ours, could perform things impossible for us at present. In fact, we*

*have seen that molecules, contained in a jar filled with air at uniform temperature, move with their velocities being essentially different, although the mean velocity of any randomly selected big quantity of them is almost exactly uniform (even). Now, assume the jar being separated into two parts, A and B, by a partition, in which there is a small hole, and that the creature, capable of seeing individual molecules, opens and closes this hole so as to let the fastest molecules pass from A into B and the slow ones from B into A. In so doing this creature, without any particular work spent, will manage to raise the temperature in B and to drop the temperature in A in contradiction to the Second Thermodynamics Law”.*

Maxwell’s demon is still bothering inventors alongside with orthodox-thinking professors. True, not everybody thinks so. Thus, R. Pohl [129] ironically says:

*“... existence of irreversible processes is an established experimental fact. Its authenticity has been reliably proved due to scientific effort of numerous Maxwell demon inventors’ failures. Because of statistic character of molecular fluctuations of all the possible material valves this demon will always remain unable to work. It is - a sleepy door-keeper”*

Publishers of J. J. Thomson’s reminiscences explained [130]: The paradox of Maxwell demon for a long time did not have any theoretical solution. And only after the approval by the science of the information a c concept, it became clear that it was an illusion, resulting from the neglect of energy spent for access to the information about the molecules velocity. Indeed, in order to evaluate velocity the demon should, at least, be able to see the molecule, for which purpose he has to illuminate it, for example, with the help of some source of light, which in its turn will require some energy for functioning. Therefore, it is assumed that the Second principle of thermodynamics is not violated. The examples of such superficial judgment are numerous. To justify own-self we wish to remind that

Hopkins (Maxwell's teacher) used to say that Maxwell was physically incapable to wrongly thinking about science. Indeed, the paradox will remain in case the energy spent for information acquisition on velocity is less than the energy yield resulting from the demon's work within the system.

J. J. Thomson [130] actually stressed this fact when he wrote: "*The demon performs his job in purely intellectual way: one can neglect the muscular effort made*" (sorry, back translation). As regards the valves, the molecular nature of which does not allow them to fulfill their mission (task), according to Maxwell, there was no intention to regard these particular devices. The case in point is: if there were a way to sort out particles as individual entities, characterized by specific velocities, the Second Law would not be valid.

Though, everybody agrees that the law does not apply to behavior of separate particles or to a limited number of them (here, again, the sand heap problem appears). And what if there were a lot of systems consisting of small number of particles? But conventional science currently refrains from making any logical conclusions out of all this reasoning and state that if in a system there appears a demon (no matter of what origin) the said system immediately falls out of reach of The Second Thermodynamics Law. Therefore, even potential existence of Maxwell's demon should be viewed as clear evidence to the Second Law's restrictions actual availability and the whole situation should no longer be regarded as a paradox.

Curiously, in USA (according to confidential information) an extensive research program has been going on for several years (Motorola, Intel Company and other) to develop micro-processors (chips) of the Maxwell demon type. It is immediately evident from Feynman's lectures. Thus, Feynman, one of the most prominent physicists of current science, in a chapter called "Ratchet and Pawl" [131] (v.1) gives a faulty analysis of a heat engine (machine) consisting of a

wheel with paddles, ratchet and pawl. When thinking along conventional lines the wheel with paddles will rotate in one direction under the impact of random blows caused by molecules. The random blows directed oppositely will not force the wheel to rotate and perform useful work, because the ratchet and pawl will prevent it. Feynman further states that the pawl subjected to impacts (blows) of other random molecules would be somewhat raised erroneously, causing failure in the machine's operation and the wheel would slightly pivot in opposite directions in a random way, and the whole system would thus fail.

But if the system with ratchet and pawl is placed in a vacuum (this is not a matter of principal importance but a purely technical problem), then there will be no molecular impact upon the pawl and Feynman will find himself in a very awkward position! In all probability we can obtain work out of random movement contrary to Feynman [132, 133] and thermodynamics [134-138]. Thus for some time in Russia they produced mechanical wristwatches with a self-starter (the self-starting resulting from occasional arm/hand movement and effected by the above ratchet and pawl with an additional small mass placed on their axis). In our youth we even intended to make a present to Professor Richard P. Feynman of such kind of a wrist-watch (in which energy required for operation is generated from random fluctuations), but, unfortunately, we did not have time to do it.

According to R. Clausius [134], the Second Thermodynamics Law states that heat cannot be transferred all by itself, free of charge (i.e. without any energy expended), from the cold body to a hot one as, obviously, one has to pay for it (just like in a refrigerator system). Indeed, heat cannot "by itself" be transferred from cold body to a hot one, even if one has to pay for it. And humanity continues to pay for it thoughtlessly directing all the engineering effort only towards reducing this pay. But the Second Thermodynamics Law does not name the payer. Today it is much more important to decide at first who is to pay rather than how

much to pay? Moreover, let anyone pay! Why should we bother about it?

In works of many scientists (particularly, by Ludwig Boltzmann [139] and Leo Szilard) it was established that the Second Thermodynamics Law was based on statistic laws. Application of the latter to thermodynamics is founded, according to Charles Kittel [138], on an a priori fundamental assumption that a closed system with equal probability may occur in any permissible quantum state. It is hardly possible to prove this assumption in terms of the UQT, because this theory does not contain closed systems. But this problem requires further serious consideration.

Sly and clever Ju Sin Chan (China) knew nothing about Clausius, Carnot and the Second Thermodynamics Law and may be because of that he had devised his bowing bird (“Chinese bird”). This brilliant toy is sometimes sold on Russian markets. It is capable of tirelessly and perpetually transforming the heat energy of environment into useful work. When its porous beak touches water in a small glass and becomes wet then, due to evaporation of water, the head temperature lowers, the ether inside condenses and flows down, the center of gravity changes and the system collapses. After the evaporation of water from the bird’s head, its body and head temperature becomes the same, the ether inside the head evaporates only partially, the system replaces the center of gravity and overturning again occurs.

The main prerequisite for the work of the toy is the requirement that the time needed for the bird’s oscillations complete attenuation be longer than that needed for the water full evaporation from the bird’s porous beak, which can occur within a wide enough temperature range. Note, that the water contained in the small glass is in a state of thermodynamic equilibrium with the environment (!).

As seen from the above, both the First and the Second Thermodynamics Laws have certain restrictions to their use and it is the UQT that is to help to establish and delineate the said restrictive boundaries. Above we had considered some

experimental effects, which apparently run contrary to the First and Second Thermodynamics Laws.

### **3.11 Gas Outflow Through Very Narrow Slot**

*“As I have more than once underlined experiment means nothing without being interpreted by theory”.*

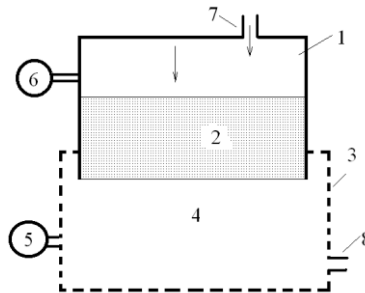
*Max Born.*

Research of compressed gas outflow through a nozzle or a slot into a medium filled with the same gas, or into vacuum, has been going on for a very long time. Usually, all researches were made in the near-sonic or supersonic zones of gas speed and for such nozzle or slot dimensions, when the outflow was of a manifest turbulent character. Not long ago multiple experiments [141] of laminar gas outflow through very narrow micron slots proved that the kinetic energy of the stream flowing out of such a slot exceeds the incoming gas energy by two and more times. The authors of such experimental research generally believe that a laminar stream carrying excessive mechanical energy in the experiment takes it from the environmental energy, to be more precise, from the atmospheric air.

It is supposed that such a laminar stream represents a direct transformer of thermal energy of the atmospheric air into mechanic energy, and quite a few researchers stick to this position. Moreover, there is only one air temperature level for such transformation and that irrespective of the operation of the transformer. It is well known that in thermodynamics, for heat to produce certain work it should move from the heater to the cooler, and it can made some work on the way (fully similar to a water flow). The proposed explanation of the results of such experiments totally contradicts the second law of thermodynamics (the



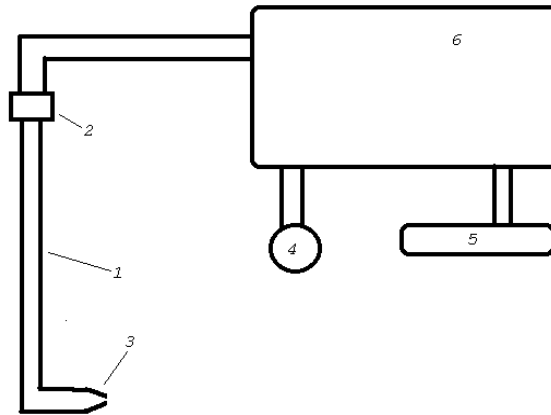
Sadi Carnot theorem). By the way, it was questioned by many great scientists (e.g. K. E. Tsyolkovsky). The idea that in the presence of the gravitation field gradient heat can pass from a cold body to a hot one along the gradient is a moving force behind many such research works and technical proposals. Let us note that the solution of the Ludwig Boltzmann kinetic equation for the heat conductivity of electron gas in a semiconductor with superposition of an external permanent electric field [142] does not predict it and leaves no hope for such effects. However, the results of multiple experiments made by Dr. Yu. I. Volod'ko [141] and others, prove the contrary. So, instead of pretending that these effects do not exist, one must offer a new explanation for them.



*Fig. 3.11.1 First measurement scheme.*

The phenomenon of an increased energy of the flowing out gas stream was first discovered experimentally in quite a different system, and was totally unexpected. Air filtration through powdered magnesia isolation used in a heat-resistant cable was studied. Fig. 3.11.1 shows the scheme of this experiment.

Compressed air is fed to receiver 1 through reducer and tube 7, and it passes through filtering layer 2 into volume 3, which can be quickly connected to or disconnected from the atmospheric volume with the help of tube 8. Surface of the filtering layer 4. Average excess pressure value is 0.41 kilogram-force per square centimeter only.



*Fig. 3.11.2 Scheme of second experiment.*

There was a possibility to sharply change (reduce or increase) for 1-2 seconds the pressure in receiver 1 and volume 3 with the help of a special device connected to tube 8 (not shown on the scheme). During the rest of the time volume 3 was connected to the atmosphere. Manometers 5 and 6 allowed creation of the pressure dependence on the time in these vessels after the filtering layer and before it from time in case of sharp pressure changed in volumes 1 and 3. Their readings in case of big volumes were changed quite slowly. 10 measurements of this kind were made, each having its own thickness of the filtering layer and its own pressure in the receiver. Knowing the air consumption and pressure values, it was possible to calculate the gas speed in the filtering pores of magnesia isolation using the standard methods. A very big value of excess pressure on surface 4 and a high value of outflow speed were discovered. This allowed calculating the “thrust” of the system, and it turned out to be about 4000 kilogram-force per square m (!!!), but the value itself was not measured.

The determination of thrust in the nozzle section was made in other direct experiments. The relevant scheme is shown in Fig. 3.11.2. Flexible tube 1 is suspended in such a way that one end is hanging vertically and can deviate as a

pendulum with revolving fixing in point 2. The end of the tube is equipped with a cap with nozzle 3 and a load, and the air flow from the nozzle is directed horizontally. The second end of tube 1 is connected to receiver 6 equipped with manometer 4, where pump 5 can feed compressed air. The air consumption through the nozzle was measured by the volumetric method with the help of a thin rubber bag, which was connected to the nozzle for a fixed period of time. Thrust (deflecting force) was defined by the deviation angle of the cap with the nozzle. It is known that jet engine thrust equals:

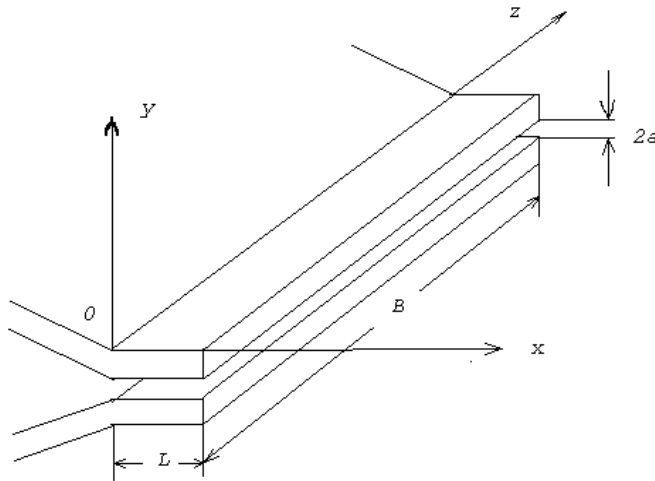
$$F = G(u - V) + (P - p)S \quad (3.11.1)$$

where  $G$  is the mass gas consumption,  $u$  is the gas outflow speed,  $V$  is the aircraft speed,  $P$  is the absolute pressure on nozzle section,  $p$  is the atmospheric pressure,  $S$  is the nozzle cross-section,  $F$  is the nozzle traction. In this equation  $u$  and  $V$  are regarded as measured in relation to the Earth, and value  $u - V$  is thus the gas speed relative to the nozzle. The first term in this equation is the “reactive force”, which includes mass gas consumption. The second term does not include gas consumption, but consumption is necessary for pressure distribution and, consequently, for difference  $P - p$ . The idea under consideration can be more profitable and economic, when the first term is smaller and the second one bigger. This will create conditions for small gas consumption and a big thrust simultaneously.

45 nozzles were tested, each of them (Fig. 3.11.3) representing a flat slot with clearances  $2a$  from 8 to 133  $\mu\text{m}$ .

The length of the route the air passes in clearance  $L$  is between 0.2-62 mm. For all nozzles the slot clearance is much less (by 75-1600 times) than slot width  $B$ , measured across the air movement direction, and the length of the route  $L$  of the air in the slot is 2-1200 times bigger than its clearance. The calculated  $O$ . Reynolds criterion was below 1000 for all measurements, and the gas movement speed in the

slot was about 100m/s, which testifies to the laminar character of the flow.



**Fig. 3.11.3** Slot appearance and coordinate system.

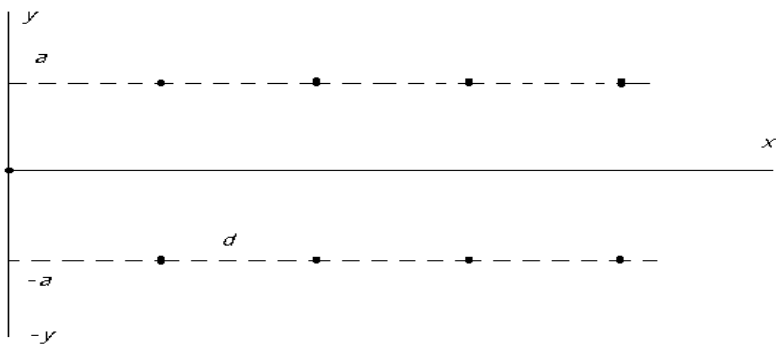
If the nozzle thrust is divided by its cross-section of the narrow internal channel, the resulting value will have pressure dimensions. It can be called “effective pressure”. It is surprising, but measurements show the excess of the pressure in the receiver (the input) by 2-4 times, which is equivalent to a molecular speed increase, since pressure is composed of the blows of different molecules, and the higher the molecular speed the greater the pressure.

The gas speed increase effect after the exit from a narrow slot leads to simultaneous increase of both terms in equation (3.11.1). The measurements show that the role of the small value of the slot width is not to reduce consumption, but mainly to make the flow laminar. In this case one can observe that the gas speed at the end of the slot is bigger than at the beginning. Numerous experiments show that the kinetic energy of the flowing out gas exceeds by twice and more the energy spent for air compression. In other words, the gas molecular speed at the nozzle (slot) output exceeds the input molecular speed at the

beginning of the slot by 2-4 times. This incomprehensible effect contraries the modern gas dynamics and leads to a considerable growth of excess pressure. As the width of clearance  $2a$  increases, the effects gradually disappear.

All these experiments were repeated in February 1988 in the Lavochkin NPO by a group of researchers: A. M. Baklunov, I. E. Karetkin, E. G. Antonov, Yu. V. Lyutykh, S. M. Trusov, and N. I. Stepanishcheva. They received nearly the same results [141]. These experimental data shows that if many very narrow slots are made on a closed bearing plane and air is pumped into the volume with the help of a compressor, then it would be possible to create a completely new type of aircraft based on a new flight principle and reminding a helicopter by its flight characteristics. About 70-80% of the thrust in such a device will be obtained due to consumption of excess static pressure at the nozzle section, and the remaining 20-30% will be due to the reactive action.

Dr. Yu. I. Volod'ko [141] and others believe that the resultant additional energy is taken from the environment (!), where it exists not as mechanic energy, but as dispersed heat energy. The authors of the book totally disagree with it and give another, and more natural, as it seems to us, explanation to these wonderful experiments by Yu. I. Volod'ko.



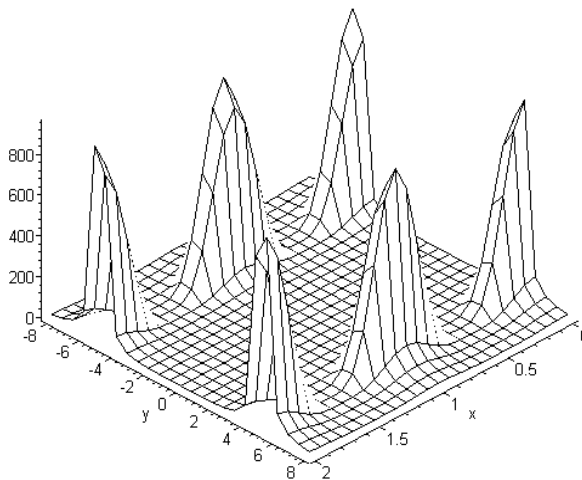
*Fig. 3.II.4* Coordinate system in slot.

Further to abovementioned the absence of translation invariance of movement equations with an oscillating charge imply lack of energy and impulse conservation laws for them. In this case a particle in a narrow slot will periodically bumps into the walls while moving and in a result of many bumps can accumulates extra energy. With certain geometry of the slot, the processes of particle energy reduction after many bumps can be suppressed. It slightly resembles the “Maternity home” solution for the processes happening in a harmonic oscillator.

Let us consider the two-dimensional problem of particle movement in a potential created by a double chain of point sources (the atoms of the slot walls), with period  $\pi$  and distance between the chains  $2a$  (the width of the slot clearance). The choice of this potential is connected with calculation problems.

$$U(x, y) = Q^2 \left[ \frac{\cos^2(\pi x)}{(y^2 - a^2)^6} + \frac{\cos^2(\pi x)}{(y^2 + a^2)^6} \right]^2 \tag{3.11.2}$$

The potential with  $a=5$  looks as follows:



**Fig. 3.11.5** Potential in slot clearance. Particles are moving along the  $x$  axis.

If the gas molecular speeds is very small, the interaction potentials will be either of the J. Van-der-Waals (Mie-Lennard-Jones) type:

$$U(r) = \frac{A}{r^{12}} - \frac{B}{r^6},$$

where A and B are certain constants different for different molecules; or of the Buckingham type, where the repellent term is an exponent. Since the interaction potentials of the gas molecules with the slot walls are very complicated and depend both on the slot atom and gas molecule parameters, the value of the dipole moment and their orientation, the task seems to be almost hopeless, and its strict solution is hardly feasible in the near future. Fortunately, as the modeling shows, the effect under consideration has a weak dependence on the concrete repulsion potential type. For example, in the cases of repulsion potentials (the exponential, the coulomb, dipole  $U(r) = \frac{A}{r^2}$ ) the general quality picture of the processes changes but little. In future we will ignore the part of the potential connected with gravitation, and will consider the repulsion potential as approximately the same:

$$U(r) \sim \frac{A}{r^{12}}$$

But if we will try to write the potential of a chain of several dozen atoms, the final equations will be very complicated for numerical modeling, and the best PCs will be altogether helpless. For this reason we use numerical calculations of slightly modified simple type potential (3.11.2).

Such a potential will create repulsion forces along the x and y axes:

$$F_x = -16\pi Q^2 \sin(\pi x) \cos^3(\pi x) \frac{(y^{12} + 15y^8 a^4 + 15y^4 a^8 + a^{12})^2}{(y^4 - a^4)^2}$$

$$F_y = -96Q^2 \cos^4(\pi x) y^3 \frac{(y^{27} + 36y^{23}a^4 + 365y^{19}a^8 + 848y^{15}a^{12} + 651y^{11}a^{16} + 140y^7a^{20} + 7y^3a^{24})}{(y^4 - a^4)^{13}}$$

Movement equations for a particle with a unit mass will appear:

$$\frac{d^2x}{dt^2} + F_x \cos^2\left(x \frac{dx}{dt} + y \frac{dy}{dt} + \varphi_0\right) = 0$$

$$\frac{d^2y}{dt^2} + F_y \cos^2\left(x \frac{dx}{dt} + y \frac{dy}{dt} + \varphi_0\right) = 0$$

This system has been solved numerically by Runge-Kutt-Merson method with automatic pitch selection. Since these movement equations are approximate, type of potential is approximate too, the main thing in further modeling will be to establish the effect of particle acceleration in a narrow slot after numerous bumps against the slot walls, and the only requirement to be met will be:

$$\lambda \approx 2a$$

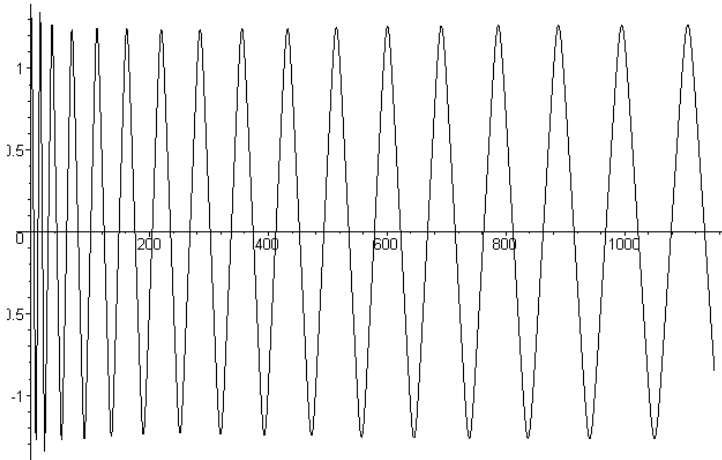
In other words, de Broglie wavelength of particles moving in the slot clearance must be of the same order with the slot width. This is what happens in the experiment. The movement equations are solved for the following starting conditions:

$$a=2, \varphi_0 = 1, Q=100, x_0 = -1, y_0 = 1, V_0x = 1, V_0y = 0.23.$$

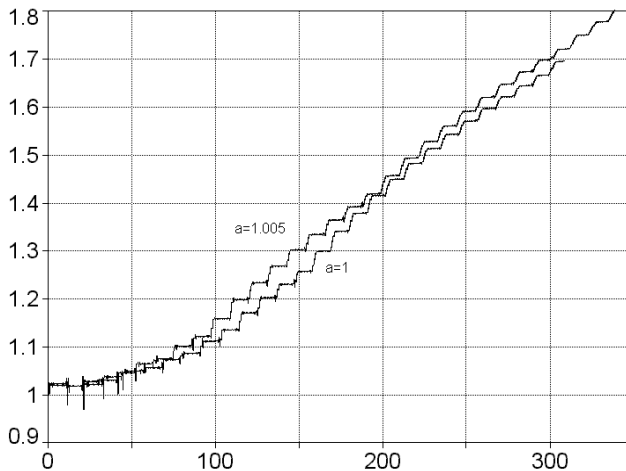
The resultant movement trajectory of the particle in the slot is shown in Fig. 3.11.6, where characteristic oscillations of the particle can be seen along the y axis, when the particle bumps against the walls, and the forward movement itself happens along the x axis with certain acceleration. Let us note that the graph is much compressed along the abscissa axis, which is made to fit in more oscillations. In reality such ordered oscillations cannot take place for a long time, and the length of the trajectory should be of the order of the length of the free path of molecules in



gas. Hence the limitation of slot clearance width  $2a$ , which should be much less than the free path length in gas. For these reasons (not only for quantum ones) the effect will depend on the clearance width. When clearances are small, this dependence will have a complicated periodic character, but when value  $2a$  increases, the effects shall totally disappear, which is observed in the experiment.

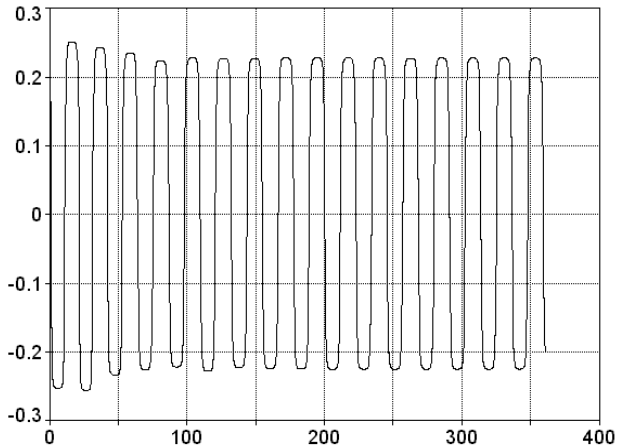


**Fig. 3.11.6** Trajectory of particle movement in slot.



**Fig. 3.11.7** Growth of particle speed  $V_x$  depending on route  $L$  along axis  $x$ .

It should not be assumed that the speed growth along the x axis happens due to speed reduction along the y axis. It is seen from Fig. 3.11.7. that the particle energy is up nearly 4 times, and the speed along the y axis remains practically unchanged, which is well illustrated by Fig. 3.11.8.



**Fig. 3.11.8** Speed dependence  $V_y(L)$ .

In real systems energy growth can hardly be more than double, since multiple encounters with gas molecules stop the increase of  $V_x$  following the growth of  $L$ , because measuring the particle speeds leads to its falling out of the energy accumulation process. Of course, under other starting conditions, the particle, as a result of bumps against the slot, may reduce its energy, and this alternative process might worsen the effect. To find it out, mathematical modeling should be made for a flow of many particles with random speeds and initial phases, and in a more real potential. But such research requires a good supercomputer, which the authors do not have.

### **3.12 Generation of Excess Energy During Charged Cluster Acceleration (*This Section Was Written Together with Prof. Hal Fox - USA*)**

*Caesar: Let me have men about me that are fat;*

*Sleek-headed men and such as sleep o' nights;*

*Young Cassius has a lean and hungry look;*

*He thinks too much: such men are dangerous.*

*William Shakespeare, "Julius Caesar"*

For the last 20 years, both in Russia [47] and abroad [48-51], research has been underway of the generation and properties of electron clusters, which appear on pointed cathodes with large currents of autoelectronic emission. The first research in this sphere was started by Kenneth Shoulders [48-51]; later independent research was made in Belorussia by Dr. Ilyanok and in 1966 in Russia by Dr. G. A. Mesyats [47]. These researchers discovered two extremely interesting facts:

1. Electron current is generated by sufficiently stable electron clusters consisting of  $10^9 - 10^{11}$  electrons with a size of the order of 20 microns. Sometimes such a cluster can seize up to a million heavy positive ions.
2. These clusters acquire during acceleration (nobody knows how?!) an energy, which exceeds by 30 and more times the value possible when the charge passes the used potential difference.

These phenomena (especially the second one) are absolutely incomprehensible

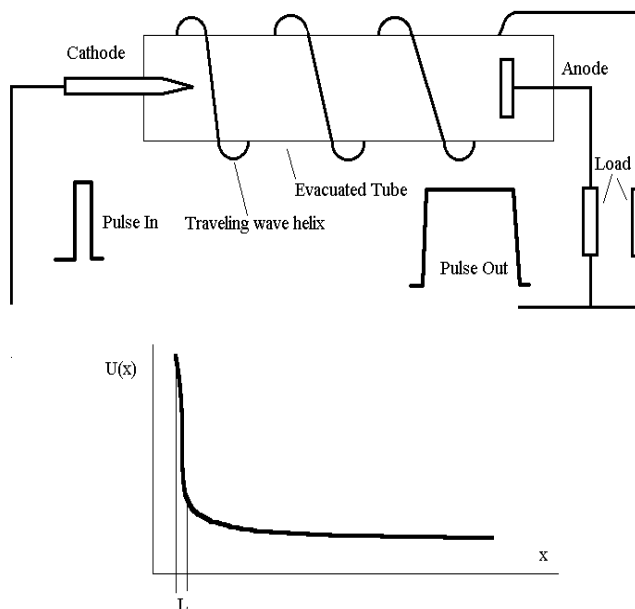
from the point of view of the ordinary physics, and we will discuss these two problems below.

Clusters widely spread in nature are ordinary polytropic balls, which are prevented from dispersion by gravitation and other (Van der Waals) forces, among which stars (including neutron) and spherical star clusters can be rated. However, gravitation forces for electron clusters are too small to hold such a cluster from repulsion and dispersion under the effect of the coulomb forces. To hold the cluster charges together, it should be assumed that electrons in the cluster are moving in some complicated way and all together generate a self-consistent field, which has a potential hole retaining the electrons inside it. This idea goes back to famous Russian physicists Ya. Frenkel and A. Vlasov and then to Dr. Vladimir Sapogin, who devoted a whole monograph [21] to this issue. Unfortunately, he did not examine the questions concerning the stability of such a formation meeting with great mathematical difficulties. On the other hand, Kenneth Shoulders realized that the problem of cluster existence should be somehow explained, and he offered a certain qualitatively similar mechanism. According to Kenneth Shoulders [48-51, 156, 157], an electronic cluster is a toroid (of the vortex type), which is held from dispersion by its own magnetic field. This is a kind of speculative analog of the well-known pinch effect, when a plasma current filament is pressed out by its own magnetic field and thus is kept from expansion. Unfortunately, Kenneth Shoulders did not make any quantitative evaluations, and the authors have neither courage nor time to solve such an excessively difficult mathematical problem.

According to Kenneth Shoulders' measurements, such a cluster has rather small longitudinal (perpendicular to movement) dimensions, which fact is important for our further analysis. We can summarize the first item as follows: numerous experiments undoubtedly confirm the existence of such clusters, and

they speculatively can be imagined, which soothes the mind somewhat.

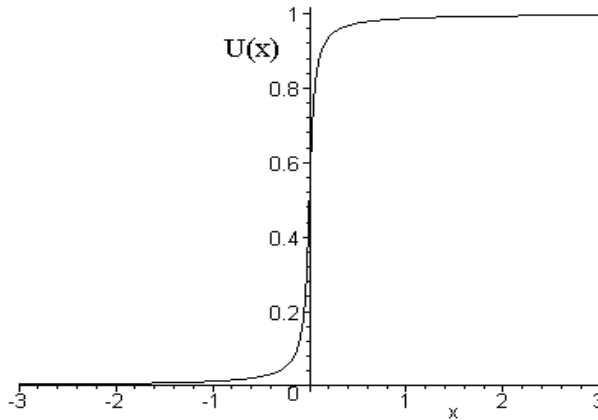
But generation of excess energy of such clusters in experiments cannot be explained in the framework of the existing standard science based wholly on energy and impulse conservation laws, and no tricks in the framework of standard science would produce such an explanation. We will try to give some explanation to the emergence of such excess energy.



**Fig. 3.12.1** Principal scheme of experiments with clusters.

The typical scheme of Kenneth Shoulders' experiments is shown in Fig. 3.12.1. Distribution of the electric field potential  $U(x)$  along the Evacuated Tube can be conditionally shown in the diagram placed below the scheme. The biggest electric field gradient exists near the spike, and length  $L$  of such a strong gradient does not exceed 1-2 Angstrom units. Far from the point, the field can even be periodic, but the amplitude of such changes will be extremely small compared to the field change near the spike. Calculations show that the field far from the spike

will have a weak effect on the ongoing processes.



**Fig. 3.12.2** Normalized potential used for mathematic modeling.

In the case of thermoelectronic emission, the electrons flying out of the cathode have approximately evenly distributed initial phases, because such a current is conditioned by electrons having kinetic energy over the barrier height (output work) and thus overcoming the barrier. Contrary to this, all the current of the autoelectronic emission is due to the electrons having overcome the potential barrier on the metal surface with the help of the tunnel effect, and, in accordance with the UQT, all the electrons that have passed have approximately the same phase. The existence of the same initial phase of all the electrons possibly affects somehow the cluster formation process, but so far it is no more than just an intriguing and very vague idea. Experiments show the cluster having very small longitude dimensions (is flat).

Potential can be approximated within bounds of mathematical modeling of experimental scheme shown on Fig. 3.12.1 by the simplest normalized function

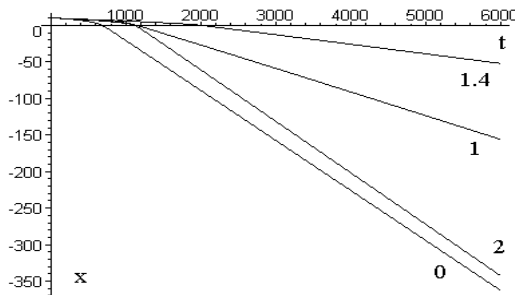
$$U(x) = \frac{1}{\pi} \arctan(ax) + \frac{1}{2}$$

the graph of which is given in Fig. 3.12.2.

Since all electrons in the cluster have equal initial phases, the movement equation for each electron in an external field with potential  $U(x)$  has the following identical form:

$$m \frac{d^2x(t)}{dt^2} + \frac{2U_0}{\pi(1+d^2x(t)^2)} \cos^2 \left( \frac{mt}{2\hbar} \left( \frac{dx(t)}{dt} \right)^2 - \frac{mx(t)}{\hbar} \frac{dx(t)}{dt} + \varphi_0 \right) = 0$$

where  $x(t)$ ,  $m$ ,  $\hbar$  are the coordinate of the electron as a time function, the electron mass, the Planck's constant correspondingly,  $U_0$  is the parameter describing potential near the spike, and  $\varphi_0$  is above mentioned initial phase. Unfortunately, analytical solutions of such types of equations are highly unlikely to be found, because in our view, the golden times when differential equations were precisely integrated are already over.



**Fig. 3.12.3** Cluster coordinate as a time function for different initial phase values.

Numerical solution of this was executed under the following conditions:  $a=25$ ,  $U_0 = \frac{\pi}{2}$ ,  $m=\hbar = 1$ ,  $x_0 = 10$ ,  $V_0 = -1/250$  for several values of the initial phase  $\varphi_0 = 0, 1, 1.4, 2$ .

The results are given in Fig. 3.12.3, where the graph shows the electron

(cluster) coordinates as the time function.

It is seen from this graph that the maximum cluster speed under certain values of the initial phase after acceleration can differ by 6 -10 times from the minimum speed under other initial phase values. This means that in our modeling the cluster energy can be many times higher than follows from the ordinary science. Apparently, just that phenomenon is observed experimentally. But there is one important detail: in order for this effect to be observed in mathematic modeling, the following key condition should be met: the length of the de Broglie wave of the electron before acceleration  $\lambda$  should be much greater than the size of the area with the maximum gradient  $L$

$$\lambda \gg L.$$

In all the experiments with autoelectronic emission this condition is always fulfilled. For example, the length of the de Broglie wave of the electron equals about 50 Angstrom units in the standard Pippard metal under the conditions of these experiments, and the value  $L$  has the order of only several Angstrom units. In case of the opposite ratio  $\lambda \ll L$ , this intriguing effect almost totally disappears if different solutions are analyzed. In our calculations  $\lambda \approx 250L$ .

Unfortunately, exact mathematic modeling of the experimental situation is extremely difficult because of the total uncertainty of the concrete expression of the potential value near the spike, since it depends to a great extent both on the point geometry and on the location on it of different alien atoms and even dislocations in the crystal grid.

Our task was to show that such experiments are not completely erroneous as the ordinary science so far has the right to think they are, but can have a clear physical interpretation. The above approach proves that the cluster itself carries



no special excess energy (beside the one received from the field).

Many people think that it takes the energy in some incomprehensible way from the vacuum fluctuations, but in our approach this is not the case. It is simply that the energy accumulated by the cluster in the permanent electric field depends on its initial phase.

It should be noted that excess energy accumulation was experimentally discovered by Kenneth Shoulders [48, 49], because for the cluster it is easy to measure, although the same is observed for individual electrons, but for them this fact is hard to notice, because it is necessary to analyze the distribution of probabilities of individual events.

We will not touch upon the commercial possibilities of such cluster technology, because it is not our task either. But the existence itself of such an effect can be to a certain extent regarded as confirmation of the correctness of the UQT.

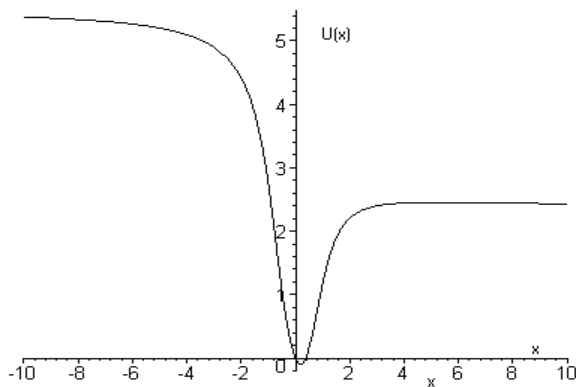
### **3.13 Spontaneous Polarization of Some Glasses and Inexhaustible Energy Source of Direct Current**

*The queer situation has arisen in the contemporary scientific world: some editorial staff do not allow the publication in scientific Journals the papers concerning the nuclear low-energetic transmutation or the devices with efficiency more, than 100%, because they contradict conventional paradigm, and others do not publish the theoretical works concerning the same questions because the corresponding experimental data are in scientific press absent.*

*The Newspaper "Duel", № 14, 1999.*

At the beginning of the last century Mary Sklodowska-Curie discovered a spontaneous temperature increase of the radioactive samples in comparison with the environment. Scientific Community met that fact with the greatest distrust, as it seemed breaking the Supreme Energy Conservation Law. But for that moment the latter survived. However, some recently discovered and absolutely unexpected facts hardly let it withstand this time.

Imagine semi-conductor (transistor) approximated in the width of its inhibited zone to the dielectric (non-conductor) [160]. Within that inhabited zone some traps could arise oriented while of the material producing by the strong external electric field. The energy (potential) of such traps can be spherically unsymmetrical and looks (1-Dimensional case) like one shown for example at Fig. 3.13.1.

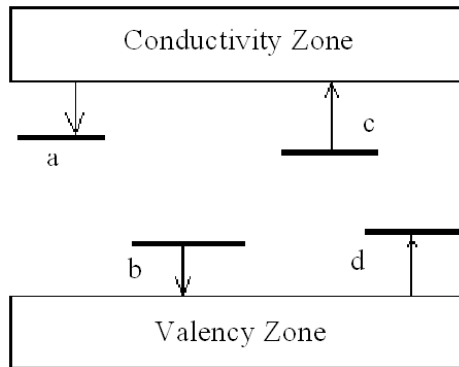


**Fig. 3.13.1** The energy (potential) of some traps can be spherically scewnes.

The electrons' behavior in that potential well trap will bear a strong resemblance to the process inside the Correa reactor described above in section 3.5. When electrons fall in such traps there the solution called “Maternity Home” can be realized. Electrons according to that solution acquire power after series of oscillations inside the trap and they leave the trap moving in one direction (to the right), in essence spontaneously, creating so direct current without any additional outside efforts. The idea of using such effect to create the energy sources

normally arises from the Unitary Quantum Theory. The authors comprehended it far ago but worried even to speak about because of its suddenness and improbability. But today there are considerable proofs of the existence of that effect studied and utilized by Prof. Valery M. Sobolev and his group with the use of especially prepared glasses. To our regret we do not know strict scientific publications or reports of that group, but the entire fact of the creation of the inexhaustible energy source by that group is widely discussed in mass media, see also Journal “New Energy Technologies” #5(8), page 70, 2002 published by Faraday Laboratories Ltd.

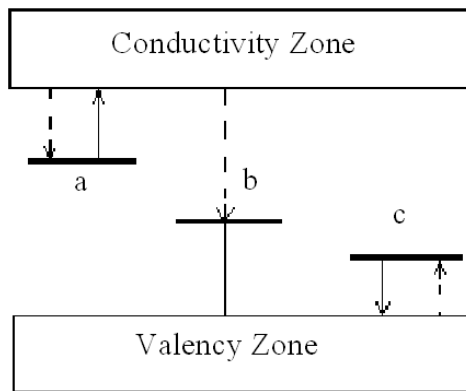
Let us treat these ideas in details.



**Fig. 3.13.2a** *The ordinary crystal lattice has with discrete levels of energy and forbidden zones.*

As usual crystal lattice contains the formations, which break its periodicity. Here electrons' localization (capture) can occur from the conductivity zone or holes out of valency zone. Exactly these formations serve as wells (traps). They can differ by their origin: for example, alien (admixed) atoms in the lattice points or interstitial space, vacant lattice points (Schottky defects), atoms accented from equilibrium positions (J. Frenkel defects), dislocations, micro-crystals' bounds. According to zone theory of solid state such crystal lattice irregularity are entailed with discrete

levels in forbidden zones of the electronic state power spectrum (Fig. 3.13.2a). In the quantum states corresponding to these discrete levels electrons are localized in the traps. Electron localization arises at its transition from the conductivity zone to the discrete level a Fig. 3.13.2a. Electrons transition from the discrete level b to the valency zone may be considered as hole's capture by the trap (adhesion). The reverse transfer c and d – are the effects of delocalization of the electron and holes (liberation, throwing out).



**Fig. 3.13.2b** *The trap may be the center of the holes adhesion*

The simplest model of the trap is hydrogen-like atom. If the crystal dielectric coefficient is high enough (for such glass it is  $\epsilon \approx 10$ ), the influence of the crystal lattice electric field can be described by means of crystal polarization. In this case the binding energy of the electron inside the trap equals to  $E \approx \frac{m^* e^4}{2\hbar^2 \epsilon^2} \approx 0.1 - 0.05$  eV, the Bohr orbital radius of the localized electron in primary state is -  $r = \frac{\hbar^2 \epsilon^2}{m^* e^2} \approx 5$  Å. Thus geometrical section of such trap equals about  $25 \cdot 10^{-16} \text{cm}^2$ , as for the examining capture cross-sections their dimensions are limited within  $10^{-12} - 10^{-22} \text{cm}^2$ . Electron has after the capture by the trap two possibilities either to be thrown into the conductivity zone again or to pass to the valency zone. If the possibility of electrons thermal throwing into the conductivity zone prevails, the

trap is an adhesive center. In the case of predomination of the electron transmission into the valency zone, i.e. in the case of the hole capture right after the capture of the electron, the trap serves as a center of abundant electrons and holes recombination. Similarly the trap may be the center of the holes adhesion, as it is shown at Fig. 3.13.2b. In that case the hole captured from the valency zone returns to that zone again.

The character and the properties of the trap are determined by the power and conditions of its level or levels, if the trap is polyvalent, as well as by the effective electron or trap capture cross-sections or by the electrons and holes densities in the zones. The latter depends on the Fermi level or quasi-levels of the material. The trap may serve as donor or acceptor, center of adhesion or recombination, luminescence activator or extinguisher. Unfortunately in solid-state physics the questions dealing with these phenomena – are the mostly complicated and do not have any conventional technical terms. The energy increasing of all electrons or of their majority inside the traps and their flying out mainly in one direction requires the strong deformation of the spherically symmetrical field of the trap, as well as their definite orientation with respect to some selected direction.

Such a result may be achieved if one use as a material a special glass exposed at the stage of fusion to strong electric field. The exposition is to be stopped after total cooling only. The non-stoichiometric character of the glass (quite general situation for all glasses) results unsymmetrical character of the traps due to the different natures of the neighbor charges (atoms) surrounding the trap.

The glass as a material combines in either one or other proportion vitreous and crystal phases. It can be obtained in the process of metals' oxides and natural materials agglomeration. And in the cases of the glasses partial crystallization there are rather promising materials like glass-ceramic and glasses studied by

Prof. Valery M. Sobolev group can arise. For example, the well-known astro-glassceramic has within quite wide range of temperatures vanishingly small linear expansion factor. That means that the atoms belonging to the astro-glass-ceramics structure are positioning inside potential wells with strictly parabolic shape. It is quite astonishing fact.

We have no idea about Sobolev's glasses' technologies. From the reporters and eyewitnesses attended at the materials production and measurements of their parameters, we know that mostly the result looked like transparent pieces like blue quartz (might be because of the cobalt or ferrous oxide admixture). But on the assumption of the above mentioned the said glass in the process of melting should be obligatory positioned inside the strong electric field and has to be cut off after total chilling only.

It should be done for the nonequilibrium state freezing. Only then the material will contain the electron traps with strongly asymmetrical field each is oriented by electric field (like dielectrics' dipoles while its polarization). The entire material by its nature will be similar to the well-known electrets. If positioning that material between condenser's segments (in the experiments of Prof. Sobolev the tension arose has the value up to 1500 V within 100 cubic cm of glass) it could be discharged giving useful load. The condenser will be discharged by delivering its power, but after some time (about 3-4 hours) its charge will be restored to the initial value and the process can be reproduced again and again, in principal - unlimitedly.

The operational principle of that glass is the following: electrons in the traps (adhesive centers) start oscillating due to heat fluctuations and if the initial phase is appropriate for the "Maternity Home" solution, then this electrons having conducted some energy will fly out of the traps moving mainly in one direction.

The negative charge at one side of the sample increases until the electric field arose begins to break the electrons flying out of the trap and totally stops the process. After the condenser discharging that surplus negative charge disappears and the process can be repeated once again: after 3-4 hours electrons will be accumulated at one side of the sample and so on and so on. The ordered spontaneous motion of the electrons creates magnetic field that was also fixed during the experiments. In fact if take quite a big sheet of such a glass with the sprayed capacitor plates there will be always direct voltage on them creating the direct current within the unlimited period of time.

We should underline that according to our point of view the energy does not appear from the outside (gravitational, electric or magnetic fields, heat energy of the fluctuations) but is generated inside the traps from nothing. These are the laws of motions for the single quantum micro-particle.

The theorists of the Sobolev's group do not have any clear explanations of the exposed facts and intend to create in future "some theoretical model of the ordered structure on the basis of the magneto electric theory – generation arising inside the dielectric crystal of the magnetization induced by the electric field.

The theoretical model may be created basing on the Landau thermodynamic theory of 2nd type for the phase transitions generalized in case of the dielectric matrix of the melt magnetization by the electric field of the charge, that is an internal parameter of the melt and belongs to the structural element of the melt" (such are the words official information on Internet). However we should note that contemporary theoretical science is based entirely on conservation laws and every logically correct corresponding analyses does not allow to obtain the results exceeding the limits of these laws. The new physical theory, the new picture of the world is required only for explanation of Sobolev's results. We propose Unitary Quantum Theory [1-9, 53-58, 81-90, 200, 201].

Let us note that standard view point terms cannot explain the work of any inexhaustible energy source also by using the ideas of energy transformation adopted from the surroundings because of meeting principal obstacle once again (theorems of Carnot and circulation).

We are considering below some theoretical illustration of electrons' behavior in such traps that due to the data lack does not relate any concrete glass model.

Examine for the illustration the motion of the electric charge inside the potential well, determined by the potential:

$$U(x) = -\arctan(x) + 2.5 \arctan(x^2), \quad (3.13.1)$$

corresponding to the diagram at the Fig. 3.13.1. The motion equation of such a particle looks in accordance with our theory like (non-autonomous variant):

$$\ddot{x} = \left( \frac{1}{1+x^2} - \frac{5x}{1+x^4} \right) \cos^2 \left( \frac{1}{2} t \dot{x}^2 - |x\dot{x}| + \theta \right), \quad (3.13.2)$$

where the particle's mass and charge as well as the Planck's constant for simplicity are considered equal to the unity. The very essential role here has so called initial phase  $\theta$ , as the solution character  $x(t)$  mostly depends on its value.

Examine the graph  $x(t)$  as the function of time  $t$ , obtained by numerical integration (we hardly can expect the construction analytical solution) of that equation for initial data  $x(0)=0, \dot{x}(0)=0.1$  (Fig. 3.13.3) and initial phase  $\theta = 0.6$ .

We can see that the particle leaves the potential well (trap) after approximately  $t = 70$  units of time and after a series of the monotone increasing oscillations. We can see from the corresponding graph  $\dot{x}(t)$  that the particle velocity gains after sufficiently complicated oscillations before flying out the trap the value

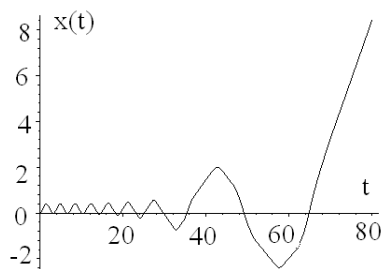


exceeding initial velocity  $v_0 = 0.1$  nearly 5.5 times. The charge oscillations remain in full measure that is seen from the analysis of the value  $|\cos(\frac{1}{2}t\dot{x}^2 - |x\dot{x}| + \theta)|$  as t function. That behavior of the particle is typical for the other values of the phase  $\theta$ , except some interval around the value  $\theta = \pi/2$  (that value is critical in some sense).

If considered the particle motion in the case of the potential

$$U(x) = -0.2 \arctan(x) + 2.5 \arctan(x^2), \quad (3.13.3)$$

(the left arm of the potential for  $x \rightarrow -\infty$  is higher than its right arm for  $x \rightarrow \infty$  merely at 0, 6, that is essentially less in comparison with the arms potential (1)) the pattern of the motion is more complicated. Viz.  $x(t)$  at the initial velocity  $v_0 = 0.1$  and phase  $\theta$  within the intervals from 0 to 1.2 and from 2.0 to 3.0 continuously oscillates, at the phase  $\theta = 1.4$  electron flies out the trape after the time  $t = 250$  with the velocity  $v \approx 2.5v_0$ , at the phase  $\theta = 1.41$  we get the reverse flying out, at the phase  $\theta = 1.42$  – the result is the flying out with the velocity  $v \approx v_0$ , at  $\theta = 1.46$  - flying out with the velocity  $v \rightarrow 0$  without initial oscillation and so on. But in the case the initial velocity is  $v_0 = 0.5$ , then for the most part of the phases  $\theta$  lying out of the critical range around  $\pi/2$  the particle flying out of the well with the velocity exceeding 1.2 – 1.3 times its initial velocity  $v_0$  with velocity nearly equal to  $v_0$ , at the phases  $\theta = 0.2, \theta = 2.6$  we get the reverse flying out and so on and so forth.



**Fig. 3.13.3** *Growth of the energy in potential wall.*

In the cases of the initial velocities being between 0.1 and 0.5 we can see intermediate patterns. Thus we can assert that the computations confirm the general tendency of the particles to fly out the potential well in one direction mainly (to the right) with increased velocity for the potential types (3.13.1), (3.13.3) and initial velocities lying in the proper intervals.

We would like to pay also attention to the other effect observed by the group of Prof. V. M. Sobolev, namely, the luminescence (self-luminosity) of obtained glasses during unlimited period of time. Such phenomenon (not requiring the external energy source for its existence) may appear in sufficiently deep potential holes possessing on its upper part the metastable level.

The considered above process of electron's oscillation in such potential hole (Fig. 3.13.3) may lead to the increasing of electron's energy and to the transition of electron on metastable level, which is determined by alloying admixture. If such transition is permitted then the dipole radiation (glow) will be realized. This phenomenon, which is new in principle and is not to be explained from the viewpoint of modern science, may be used on a large scale.

Meanwhile we are not going to comment the other numerous and highly interesting phenomena, examined with the use of these glasses.